

# 10<sup>th</sup> Students' Research Symposium (SRS)

## SRS PROCEEDINGS

Organized by

DEPARTMENT OF FINANCE  
FACULTY OF COMMERCE AND MANAGEMENT STUDIES  
UNIVERSITY OF KELANIYA  
SRI LANKA

*“Crafting Financial  
Strategies for the  
Next Normal”*

# **10th Students' Research Symposium 2021/2022**

**“Crafting Financial Strategies for the Next Normal”**

## **SRS Proceedings**

**Department of Finance**

**Faculty of Commerce and Management Studies**

**University of Kelaniya**

**18<sup>th</sup> January 2022**

@ 2022 Department of Finance

ISSN 2827-7236

10<sup>th</sup> Students' Research Symposium

“Crafting Financial Strategies for the Next Normal”

Responsibilities of the content of proceedings included in this publication remain with the respective authors.

**Symposium Coordinator** : Mr. H. M. A. L. Gunasekera

**Editor in Chief** : Ms. G. A. P. Kethmi

**Cover Page Design** : Mr. A. J. P. Samarawickrama

Department of Finance

Faculty of Commerce and Management Studies

University of Kelaniya

Sri Lanka

Telephone: +94112903553

Web: <http://fcms.kln.ac.lk/dep/dfin/index.php/home>

## Table of Content

Department of Finance.....	1
Message from the Dean of the Faculty of Commerce and Management Studies.....	2
Message from the Head of the Department of Finance .....	3
Message from the Chairman of the Research Council .....	4
Message from the Coordinator of the Dissertation and Symposium.....	5
FACTORS AFFECTING IN INTRODUCING MICRO-INSURANCE FOR THE SELF-EMPLOYED PEOPLE IN KURUNEGALA DISTRICT ...	6
1. Introduction .....	7
2. Literature Review .....	9
3. Research methodology .....	13
4. Findings and Discussion.....	17
5. Conclusion.....	27
6. References.....	28
THE IMPACT OF RISK MANAGEMENT ON THE FINANCIAL PERFORMANCE OF LISTED INSURANCE COMPANIES IN SRI LANKA	32
1. Introduction.....	34
2. Literature review .....	38
3. Methodology .....	40
4. Results and discussion.....	44
5. Conclusion .....	50
6. References .....	52
A STUDY OF AWARENESS AND USAGE OF E-BANKING SERVICES AMONG WOMEN WITH SPECIAL REFERENCE TO KUNDASALE DIVISION, KANDY .....	54
1. Introduction .....	55
2. Literature Review .....	57
3. Methodology .....	59
4. Results and Discussion .....	64
5. Conclusion and Recommendation .....	75

IMPACT OF COVID – 19 PANDEMIC ON DEBT SECURITIES IN SRI LANKA .....81

1. Introduction .....82

2. Literature Review .....85

3. Methodology .....90

4. Findings and Discussion.....95

5. Conclusion..... 102

6. References..... 105

EFFECT OF FINANCIAL PERFORMANCE ON SHARE PRICES DURING THE COVID-19 PANDEMIC: SPECIAL REFERENCE TO THE LISTED BANK, FINANCIAL, AND INSURANCE SECTOR IN SRI LANKA ..... 109

1. Introduction ..... 110

2. Literature Review ..... 114

3. Methodology ..... 119

4. Results and Discussion ..... 124

5. Conclusion..... 128

6. References..... 129

FACTORS DETERMINE THE DEMAND FOR MICROINSURANCE AMONG LOW-INCOME HOUSEHOLDS IN GALLE DISTRICT ..... 133

1. Introduction ..... 134

2. Literature Review ..... 137

3. Methodology ..... 139

4. Findings and Discussion..... 143

5. Conclusion..... 146

6. References..... 151

THE IMPACT OF COVID19 PANDEMIC ON THE PROFITABILITY OF THE INSURANCE INDUSTRY IN SRI LANKA ..... 154

1. Introduction ..... 155

2. Literature review ..... 158

3. Research Methodology ..... 164

4. Data presentation and analysis..... 166

5. Conclusions and Recommendations .....	172
6. References.....	174
IMPACT OF ENTERPRISE RISK MANAGEMENT ON UNDERWRITING PROFIT OF INSURANCE COMPANIES IN SRI LANKA .....	176
1. Introduction .....	177
2. Literature Review .....	179
3. Research methodology .....	184
4. Findings and Discussion.....	187
5. Conclusion.....	192
6. References.....	195
THE IMPACT OF ELECTRONIC BANKING SERVICE QUALITY ON CUSTOMER SATISFACTION DURING THE PANDEMIC PERIOD .....	200
1. Introduction .....	200
2. Literature Review .....	203
3. Research Methodology .....	208
4. Findings and Discussion.....	212
5. Conclusion .....	219
6. References .....	221

## **Message from the Dean of the Faculty of Commerce and Management Studies**

I would like to extend my warmest wishes to all participants of the Students' Research Symposium 2021/2022, organized by the Department of Finance, Faculty of Commerce and Management Studies, University of Kelaniya for the 10th consecutive year.

The Faculty of Commerce and Management Studies has been one of the pioneer Faculty at the University of Kelaniya which has taken numerous efforts to improve the research culture of its academic members and undergraduates. I am confident that the 10th Students' Research Symposium 2021/2022 will play an important role in encouraging the research culture in the University of Kelaniya while further strengthening the successful journey of the Faculty. I hope that the findings of this symposium will support to uplift the level of the country's businesses and economy which faced numerous challenges due to pandemic and the economic crisis. Further, I believe that this symposium will provide an opportunity for final year undergraduates of the Department of Finance to showcase their presentation and research skills at a common academic forum and disseminate new knowledge to society at large.

Furthermore, I highly appreciate the staff and the students for their contribution, confidence, and dedication to make this event a success. Moreover, I congratulate all the undergraduates who will be presenting their research findings in the symposium and wish all the success to the 10th Students' Research Symposium 2021/2022.



**Dr Narada Fernando**  
**Dean, Faculty of Commerce and Management Studies**  
**University of Kelaniya**

## **Message from the Head of the Department of Finance**

As the Head of the Department of Finance (Dfin), it gives me immense pleasure in issuing a message for the 10th Students' Research Symposium 2021/2022 (SRS) organized by the Department of Finance, Faculty of Commerce and Management Studies of the University of Kelaniya. The main objective of SRS is to provide an opportunity for fourth-year undergraduates of the Dfin to come together and share their research work in a safe environment. Dfin provides a supportive environment in which students can present their research findings and receive feedback from the faculty members. It was interesting to notice that this year there were a number of research studies done focusing on the Covid 19 pandemic.

Dfin is committed to fostering a research culture since it is an innovative and proactive academic department. Dfin believes that organizing SRS could develop students' critical thinking, communication and time management skills that are necessary to become an industry-ready graduates.

I wholeheartedly congratulate and wish the 10th SRS to be a success. I take this opportunity to thank all the students and staff members who were involved in research projects and organizing the SRS.



**Prof Ruwan Abeysekera**  
**Head, Department of Finance**  
**Faculty of Commerce and Management Studies**  
**University of Kelaniya**



## **Message from the Chairman of the Research Council**

It gives me great pleasure to send this message on behalf of the 10th Student Research Symposium organized by the Department of Finance of the Faculty of Commerce and Management Studies of University of Kelaniya.

Organizing a research symposium for the 10th consecutive time is not an easy endeavor. Organizing this symposium for the 10th time means that this research event has become a part of the research culture of the Faculty of Commerce and Management Studies.

Writing research abstracts and presenting them provide necessary training to the students in writing reports, public speaking and publicly defending of research findings. This training cannot be given by the normal classroom lectures.

Therefore, participating at this symposium with the timely theme of "Crafting Financial Strategies for the Next Normal" which includes mainly covid 19 impact on Economy and Business will be a memorable event for the students presenting their research for the first time.

Research Council of University of Kelaniya promotes research culture in the university, high quality publications and interdisciplinary approach to research. Starting point of high-quality research is student research symposia of this nature. Abstract of a symposium is a condensed form of a research report. It briefly includes the reason why the research was conducted, how the research was conducted, the methods used, results, conclusion etc. Therefore, this conference prepares students for writing full papers in future.

I praise the leadership of Dr. Narada Fernando and Prof. Ruwan Abeysekara in providing opportunities to the students. I wish you all a very fruitful symposium.



**Senior Prof. Kapila Seneviratne**  
**Chairman**  
**Research Council**  
**University of Kelaniya**

## **Message from the Coordinator of the Dissertation and Symposium**

It gives me immense pleasure to welcome you to the 10th Students' Research Symposium 2021/2022 at the Department of Finance, Faculty of Commerce and Management Studies. The Department of Finance initiated the SRS in 2012 as the first-ever Students' Research Symposium at the Faculty of Commerce and Management Studies. This year, by continuing the tradition of transforming knowledge for the betterment of business and society, SRS is unfolding as a virtual symposium for the 10th consecutive year under the theme of "Crafting Financial Strategies for the Next Normal". It creates a platform for 126 undergraduates at the Department of Finance to share knowledge and expertise on the business management discipline and their application in various sectors in order to create a positive impact on business and society at large.

This time a considerable number of research are linked with the Covid – 19 and its impact on the business and economy. The keynote speech of the SRS was delivered by Dr. Ruwani Fernando on a timely topic. The success of the 10th SRS 2021/2022 depends on the contribution and the commitment of many parties including the organizing committee, university administration, speakers, scholars, researchers and presenters. While extending a deep sense of gratitude to them, I wish SRS a successful journey ahead.



**Mr Asitha Gunasekara**  
**Coordinator, Dissertation and Symposium**  
**Department of Finance**  
**Faculty of Commerce and Management Studies**  
**University of Kelaniya**

## FACTORS AFFECTING IN INTRODUCING MICRO-INSURANCE FOR THE SELF-EMPLOYED PEOPLE IN KURUNEGALA DISTRICT

Amarasekara M.S.P.C.G. <sup>1</sup> and Fernando. J.M.B.R<sup>2</sup>

### Abstract

**Introduction-**The objective of this study is to examine the factors that affect the enhancement of outreach of Micro Insurance Services available for the self-employment sector in the Kurunagala district. The concept of micro-insurance is more prevalent in third world countries and the need for financial services for the poor is now universally accepted. Micro Finance (MFI) was launched to provide a formal risk protection scheme and minimize poor household facilities and the idea of micro-insurance was born.

**Design/Methodology/Approach-** The study used deductive approach. The study employed a survey questionnaire to collect the data and the sample consist with 113 respondents. Willingness to pay, accessibility, affordability, and consumer trust were used as the factors affecting introduction of micro-insurance schemes.

**Findings-** Willingness to pay, accessibility, affordability, consumer trust in income has significant positive effect on the implementation of micro-insurance. The hypotheses were tested using simple regression analysis, and all alternative hypotheses were accepted and null hypotheses were rejected.

**Conclusion** – The study reveals that industry professionals and insurance companies need to pay attention to the factors such as willingness to pay, accessibility, affordability, consumer trust in deciding their micro-insurance schemes. Thus, insurance companies can introduce new eye-catching insurance schemes to eliminate or mitigate the impact of these barriers.

**Keywords:** *Micro Insurance, Self Employed People, Affordability, Consumer Trust in Insurance, Implementing of Micro Insurance*

#### Cite this paper as:

Amarasekara, M.S.P.C.G. and Fernando, J.M.B.R. (2022). FACTORS AFFECTING IN INTRODUCING MICRO-INSURANCE FOR THE SELF-EMPLOYED PEOPLE IN KURUNEGALA DISTRICT. *10<sup>th</sup> Students' Research Symposium, Department of Finance, University of Kelaniya, Sri Lanka*. 1. 6-31

<sup>1</sup>Department of Finance, Faculty of Commerce and Management Studies, University of Kelaniya  
([ganyaamara@gmail.com](mailto:ganyaamara@gmail.com))

<sup>2</sup>Department of Finance, Faculty of Commerce and Management Studies, University of Kelaniya

## 1. Introduction

Micro Finance (MFI) was launched to provide a formal risk protection scheme and minimize poor household facilities. Micro Insurance is a tool of assisting poor people to manage their risks efficiently (Churchil, 2006). There are many ways of defining Micro Insurance in different aspects. However, it is mostly engaged in managing risks pertaining to poor or low-income generating people against special perils. In 2005, Cohen and Sebstad stated that the exchange was proportional to the cost of the premium, the probability and the risk. Therefore, the service must ensure long-term sustainability. From then on, planning for social security and financial inclusions should focus on the country's national policy proposals. Finally, micro insurance should influence technology to increase penetration, simplify processes with lower delivery costs, and improve delivery quality and consistency (Churchill, 2006). In 2012, Ngerebo and Nwite stated that microfinance was a small, premium fundraising scheme from low-income individuals used to support affected individuals within the same group that contributed. Funds and payments such as insurance premiums were proportional to the premium paid. For the purposes of this study, we define Micro Insurance as a risk mitigation tool for low-income people, with an affordable premium rate, a sample, and a clear framework within the scope of the local regulatory framework. When looking at the basic operations of Micro Insurance, it is clear that lower-income groups play a vital role.

Main objective of this study is to realize the factors that affect on the enhancement of outreach of Micro Insurance Services available for the self-employment sector in Kurunegala District. Other secondary objectives are

identifying the reasons for less demand for insurance policies by informal workers of self-employment sector and identify the key issues in advisor's perspective for implementing micro insurance aimed at self-employment sector in Kurunegala District.

According to a study conducted by Balkenhol and Churchill (2002), informal risk-coping measures are insufficient to cover the insurer's expected return as a risk protection because lower-income earners and informal workers cover only a small portion of losses, the attempt to protect lower-income earners and informal workers against a variety of perils is unsuccessful. (Balkenhol, & Churchill, 2002)

This also demonstrates the high level of interest in this field of study among global researchers and economists. However, the self-employment sector received only a small amount of attention in these micro insurance studies. Self-employees have evolved from the low-income group itself, despite the fact that micro insurance research have focused on poor households. In their research of the micro insurance industry, certain literatures have combined poor household and informal employees (self-employment). The majority of academics have chosen this topic to investigate when it comes to uploading micro insurance for lower-income workers, including self-employed people. As a result, this study investigates whether characteristics or impediments have an impact on efficiently implementing a Micro Insurance program to alleviate the risks encountered by self-employed people.

Additionally, in comparison to other nations, Sri Lanka does not have a separate micro insurance regulatory structure. As a result, the institutions that are promoting this industry in the country are provided insufficient support. The study is particularly important for micro insurance practitioners in Kurunagala District, Sri Lanka, and around the world, in order to devote their attention to risk mitigation in the self-employment sector, which

employs the majority of low-income earners. This segment, however, is overlooked, and the resources available to them are restricted. Accordingly, when unforeseen catastrophic events occur, there is a chance of financial disruption (Roth et al., 2007). As a result, for future applications, this study is more important for regulators, donors, insurers, and micro insurance practitioners.

## **2. Literature Review**

Micro insurance is a type of insurance that provides coverage to low-income families. A micro insurance plan protects people with limited finances and is tailor-made for lower-value assets, as well as reimbursement in the event of illness, injury, or death. This is frequently the insurance obtained by law-abiding citizens, offered by a variety of businesses but administered in accordance with generally accepted insurance norms. Micro insurance is a package designed specifically for low-income individuals who are willing to accept a risk for a cheap premium (McCord, Ramm & McGuinness, 2006). Apart from the clearly defined target market: low-income people, this term is essentially an equivalent together might use for regular insurance.

An independent contractor or sole entrepreneur who reports self-employment income is referred to as a freelancer. Instead of working for an employer, self-employed persons work for themselves in a variety of trades, professions, and occupations. Self-employed folks may have particular tax filing obligations depending on the jurisdiction. A freelancer is someone who works for himself rather than for a company or another person (an employer). A freelancer or independent contractor that completes all of their work for a single client should be considered freelance. Self-employed people may be active in a variety of occupations, but they are typically highly

competent at a certain type of employment. Writers, traders, investors, lawyers, salespeople, and insurance brokers are all examples of self-employed individuals.

Willingness to shop is frequently expressed in a buyer's willingness to pay, which is the greatest amount he or she is prepared to spend for a particular quantity. Consumer attitudes about phony items, views of societal implications, and innovations, according to Vida, all influence the consumer's desire to purchase for fake products. According to Huber and Schlager in 2011, the buyer's financial purchasing behavior is typically influenced by the consumer's attitude and, as a result, the product perception. Consumers' decisions are frequently separated into three mental components, such as KAI (Knowledge, Attitude, and Intention), which analyze all knowledge, whether commercial and non-commercial, and ultimately influence the willingness to pay of consumers.

Income earners, who work with most of the micro finance institutes in rural communities, have identified that both their clients need credit facilities and they appear for all additional facilities like insurance facilities (Llanto, 2007). Micro Finance Institutions can provide valuable connections when they providing micro insurance facilities in Sri Lanka (Wiedmaier-Pfister, Wohlner, 2004). It's acknowledged that there's enough room to figure out the danger and insurance to develop new innovations those provide a far better access to poor (Morduch, 2006). When considering the general public health services people seek another alternative to migrate poor health conditions. Therefore, poor households rely largely on self-insurance or informal group-based risk management mechanisms where they need quick access. To extend the outreach of micro insurance for low-income households, micro insurance must be addressing the areas of accessibility, coverage, period of overage and affordability

(Cohen and Sebstad, 2005).

Micro insurance programs are rarely undertaken as a part of social protection functions which involves redistribution internal cross-subsidies or linking public subsidies to their members (Jacquier et al., 2006). While a context of rural communities, the accessibility to the health care by poor families is extremely limited since they need uneven and insufficient cash flows. So, they are seeking alternative methods like informal self-insurance and informal group-based systems which have quick access to poor community to scale back their health hazards. Because these approaches are built up with group consisting exact poor category, they have disadvantages and also the women participation is extremely high. Establishment of those informal community groups is very existed within the areas where the care given by private and government institutions is least.

Majority of micro insurance clients are often found among low-income earners who are within the Bottom of Pyramid (BOP), and their income get fluctuated frequently and also their income flow get badly affects when there are calamitous (Cohen and Sebstad, 2005). Micro insurance product developers are encouraged to style micro insurance products for low-income groups with the features of balanced price, cost, sustainability and affordability (Ahuja and Jutting, 2004). Premiums for low-income people are found out at a substantial percentage from their income (Ahuja and Guha-Khasnobis, 2005). Due to micro insurance products should be affordable by poor otherwise they are going to not accept these insurance systems. Preparations like introducing slight benefit packages, premium payment options (time option) and linking to the subsidy programs, might be arranged to beat this example (Churchill, 2006). In some instances, premium is subsidized and it is being set at a level that's not



exceeded the willing amount the people desired to pay (Biener, 2013). Alternatives like distance-based insurance may cause growth of affordability by enabling customers to shop for insurance policies consistent with their risks as they will afford. Insurance premium for lower income group is often made cheaper by applying hazard mitigation procedures. However, a national level discussion is required to spot who should support the prices of creating insurance inexpensive to those that are in need (Kousky & Kunreuther, 2014). In the absence of support from international aids or government subsidy systems for low income households find it difficult to get insurance, and in such situations they will apply few affordable options for mitigating disaster risks in their lives including insurance as a risk mitigation tool (Linnerooth-Bayer, Mechler and Pflug, 2005). Introducing a subsidy scheme for insurance is that the straightforward thanks to make insurance cheaper to lower income group. On the opposite hand, the insurers are being more efficient and aware of consumer preference, and it also encourages customers to request risk-adjusted premiums. However, these are not available to the people that are in high-risk category. Trust can be defined in different forms to address various types of concerns (Ma and Orgun 2006). Trust is a key factor which can influence in determining the customer perception and their relationships with the organizations (Taylor, 2001). Trust has become a vague principle in the field of Health Insurance and at the same time it can be categorized in to three directions such as client's trust in provider/agent, trust in insurers and trust in legal contracts of insurance (Schneider, 2004).

### **3. Research methodology**

#### **3.1 Population and Sample**

Populations of the study's participants is based on the self-employed people in the Kurunegala District. The sample were chosen from micro insurance businesses such as Co-operative Insurance Company Limited, Amana Takaful PLC, and Sanasa Insurance Company. As a result, the population is diverse in terms of soft skills, experience, and age. The self-employed who experienced complete micro insurance solutions at the ground level in the Kurunegala District were chosen as the sample. According to the Morgan table of sample size, the researcher chose 114 micro-insurance self-employed people in the Kurunegala district as the sample for this study. However, the researcher sent 450 questionnaire and finally received 123 completed questionnaires, Thus the final sample is based on 123 respondents.

#### **3.2 Conceptual Framework**

The conceptual framework depicts the influence of certain aspects (willingness to pay, accessibility, affordability, and insurance confidence) on the deployment of micro insurance for the self-employed

Figure 3.2.1: Conceptual Framework

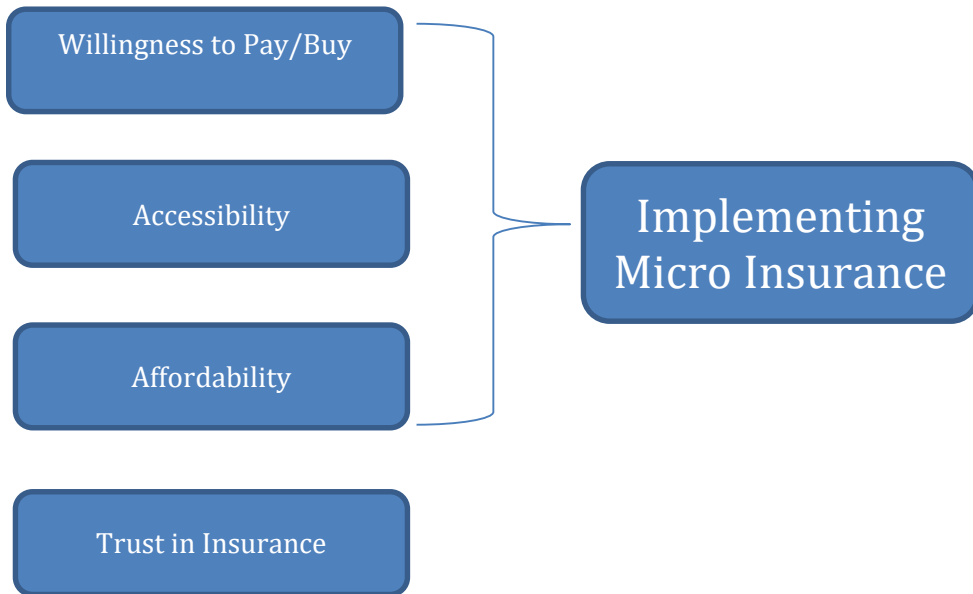

*Source: Author compiled*

### 3.3 Operationalization

Table 3.3.1: Operationalization of the variables

<b>Variable</b>	<b>Dimension</b>	<b>Indicators</b>
Factors relating to implementation Micro Insurance	Willingness to pay	Payment capacity  Amount of premium
	Accessibility	Level of closure to community  Social & cultural background
	Affordability	Level of income & expenditures  Benefits
	Consumer Trust	Building trust  uncertainty
Implementing Micro Insurance	Implementing Micro Insurance	Importance for my business

*Source: Author Compiled*

### **3.4 Data Collection**

Data were collected by using a questionnaire and the questionnaire consisted of 25 questions that were used to collect data from the study's primary sections. The essential variables for micro-insurance are preference, affordability, dependability, and accessibility, and feedback models have been constructed based on these four variables to identify the barriers to micro-insurance in the Kurunegala District of Sri Lanka and their current condition. The Likert scale approach was used to create questions. Participants in the study were asked questions and given appropriate grades based on their answers and agreement with their experiences. Scores vary from 1 to 5 on a scale of 1 to 5. (1-strongly disagree, 2 disagree, 3 moderates, 4 agree, 5 strongly agree). Even financial advisers are encouraged to develop a questionnaire that outlines the challenges to implement microfinance programs for low-income groups, including the self-employed, in this study.

### **3.5 Method of Data Analysis and Evaluation**

The researcher used Pearson's correlation coefficient analysis to assess the proposed hypotheses and determine the impact of factors affecting on micro insurance program's execution. The study employed correlation analysis to better understand the implementation of micro insurance (dependent variable) and the link between selected independent factors such as willingness to pay, accessibility, affordability, and customer confidence in insurance consultants. The correlation between two or more variables can be measured using many indicators. Pearson's

correlation, Spearman's coefficient, and Kendall's finger coefficient are considered to be the most prevalent techniques of determining coefficients employed in scientific analysis among the various coefficient statistical analyses. Pearson's correlation approach, a quantitative indicator that assesses the strengths of two variable associations statistically, was employed in this investigation.

## **4. Findings and Discussion**

Descriptive statistics and inferential statistics are comprised in this chapter. The first segment of the chapter details data screening, sample description, and preliminary analysis such as normality, linearity, validity, reliability, correlations, and descriptive statistics are presented. Furthermore, inferential statistics are used to test hypotheses under the analysis of regression.

### **4.1 Data Collection and Response**

The researcher collected data from the sample of self-employed people at Kurunegala district. The simple random sampling technique is used to collect data from that sample. Four hundred and fifty questionnaires were distributed in online mode to respondents through personal networks. All the Likert scale items were anchored on a five-point scale ranging from strongly disagree to strongly agree.

## 4.2 Sample Description

Table 4.2.1: Respondent's Profile

	Frequency	Percentage
<b>Gender</b>		
Male	49	43
Female	65	57
<b>Age</b>		
18-24 Years	41	36
25-30 Years	31	27.2
30-35 Years	23	20.2
36 Above	19	16.7
<b>Business Period</b>		
Less than 1 year	28	24.6
1-5 Years	26	22.8
5-10 Years	15	13.2
10-15 Years	19	16.7
15-20 Years	13	11.4

More than 20 years            13                                    11.4

---

*Source: Author Compiled*

### 4.3 Descriptive Statistics

Descriptive statistics such as Mean, Median, Mode, Skewness, and Kurtosis were obtained for the dependent (Implementation Micro Insurance) and independent variables (Willingness to pay, Accessibility, Affordability, & Consumer trust on Insurance) through the frequency distribution analysis. Mean, mode, and median are the most popular averages; mean summarizes the essential features in a series and enable to the comparison between variables, Median is not useful where items need to be assigned relative importance and weights, and mode is the frequently occurring in a series (Kothari, 2004).

Table 4.3.1: Descriptive Statistics of Variables

---

<b>Statistics</b>	<b>IMI</b>	<b>WP</b>	<b>ACC</b>	<b>AFF</b>	<b>CTI</b>
Mean	4.1500	4.3070	4.2281	4.3158	4.2456
Median	4.00	4.50	4.50	4.50	4.50
Mode	4.00	4.00	4.50	4.00	4.50
Skewness	-1.723	-1.945	-1.689	-2.146	-2.118

---



Std. Error of Skewness	0.226	0.226	0.226	0.226	0.226
Kurtosis	3.355	7.106	3.169	8.148	5.657
Std. Error of Kurtosis	0.449	0.449	0.449	0.449	0.449

*Source: Author Compiled*

#### 4.4 Validity

Validity is the degree to which a measure precisely denotes what it is supposed to measure (Hair et al, 2014).

Three main types of validity test used to assess the goodness of measures are Content validity, Criterion-related validity, and construct validity (Sekaran, 2003).

Table 4.4.1: Validity Statistics

<b>KMO and Bartlett's Test</b>		<b>WP</b>	<b>ACC</b>	<b>AFF</b>	<b>CTI</b>
Kaiser-Meyer-Olkin	Measure of Sampling Adequacy.	0.500	0.500	0.500	0.500
Bartlett's Test of Sphericity	Approx. Chi-Square	38.912	19.130	28.819	28.417
	Df	1	1	1	1
	Sig.	0.000	0.000	0.00	0.000

*Source: Author Compiled*

Table 4.4.2: Total Variance Explained of Independent Variables

<b>Construct</b>	<b>Number of items</b>	<b>ESSL cumulative %</b>
Willingness to Pay	02	77.138%
Accessibility	02	69.853%
Affordability	02	73.862%
Consumer Trust on Income	02	73.716%

*Source: Author Compiled*

#### **4.5 Reliability**

Internal consistency was used to ensure the reliability of the measurement scales. Nunnally (1978) recommended that other social research construct reliability was assessed using Cronbach's Alpha coefficient.

Table 4.5.1: Reliability Statistics

<b>Construct</b>	<b>Reliability Statistics</b>	
	<b>Cronbach's Alpha</b>	<b>N of Items</b>

Willingness to Pay	0.695	2
Accessibility	0.568	2
Affordability	0.626	2
Consumer Trust on Income	0.639	2

*Source: Author Compiled*

**4.6 Correlations**

Karl Pearson's coefficient of correlation is the most widely used correlation test method (Kothari, 2004). Found the linear relationship between variables because the Pearson correlation coefficient was used to assess the association's strength among the said two constructs.

Table 4.6.1: Correlations between Dependent Variable and Independent Variables

<b>Correlations</b>		Implementation Insurance	Micro Willingness to Pay	Accessibility	Affordability	Consumer Trust on Income
Implementation Insurance	Micro	1				
Willingness to Pay		.546**	1			
		.114				
		.000				

	114	114			
Accessibility	.646**	.676**	1		
	.000	.000			
	114	114	114		
Affordability	.618**	.870**	.638**	1	
	.000	.000	.000		
	114	114	114	114	
Consumer Trust on Income	.596**	.713**	.734**	.621**	1
	.000	.000	.000	.000	
	114	114	114	114	114

\*\* . Correlation is significant at the 0.01 level (2-tailed).

*Source: Author Compiled*

### 4.7 Hypotheses Testing

Four hypotheses are tested to come up with a strong conclusion in the current study. Separately, the researcher tested hypotheses one by one (H1a, H2a, H3a, H4a) through the multiple regression analysis.

Table 4.7.1: Multiple Linear Regressions – Model Summary

Model Summary				
Model	R	R Square	Adjusted R Square	Std. Error of the Estimate
1	.720 <sup>a</sup>	.518	.501	.666

Source: Author Compiled

Table 4.7.2: Multiple Linear Regression- ANOVA

ANOVA <sup>a</sup>						
Model		Sum of Squares	df	Mean Square	F	Sig.
1	Regression	52.068	4	13.017	29.317	.000 <sup>b</sup>
	Residual	48.397	109	.444		
	Total	100.465	113			

Source: Author Compiled

Table 4.7.3: Multiple Linear Regression - Coefficients

Coefficients <sup>a</sup>							
Model	Unstandardized		Standardized		Sig.	Collinearity Statistics	
	B	Std. Error	Beta	t		Tolerance	VIF
(Constant)	-.607	.484		-1.255	.212		
Willingness to Pay	-.495	.242	-.309	-2.046	.043	.193	5.175
Accessibility	.505	.151	.351	3.357	.001	.404	2.478
Affordability	.775	.206	.514	3.769	.000	.238	4.208

---

Consumer Trust on Income	.331	.151	.240	2.199	.030	.372	2.685
--------------------------	------	------	------	-------	------	------	-------

---

a. Dependent Variable: Implementation Micro Insurance

---

*Source: Author Compiled*

Study found an impact of willingness to pay on implementation micro insurance with the support of literature. Czura and Dequiedt, (2015) explained that the increase of willingness to pay for commitment was affected to implement insurance. According to Xia and Zeng (2006), the key willingness to shop for was frequently noticed through consumer behavior during the shopping process where Dror and Koren (2007) stated that incorporating an insurance benefits package into the enrolling process typically resulted in increased customer willingness, which could impact consumer response to micro insurance. Based on them, the researcher advanced the first alternative hypothesis as there is a significant impact of willingness to pay on implementation of micro insurance. The t-value is -2.046, accepting the hypothesis one of the study.

The researcher found an impact of accessibility on the implementation micro insurance with the support of literature. Lashley and Warner (2015) found that there was an impact of accessibility for micro insurance in the region of their sample. To overcome the hurdles to accessibility while offering insurance services to larger communities, populous countries such as China have created community-based insurance plans for larger groups (Wang et al, 2005). Standardized Coefficients Beta value of accessibility is 0.351 and it is a positive value and Sig. = .001. Accordingly, there is a positive impact of accessibility implementation micro insurance. It was similar to the

results of past researches (Lashley & Warner, 2015; Wang et al, 2005).

The researcher found a positive impact of affordability the on-implementation micro insurance with the support of literature. Alternatives such as distance-based insurance may increase affordability by allowing clients to search for insurance policies that are appropriate for their risks and that they can pay. However, in order to build a distance-based strategy, this technique will need widespread public support (Litman, 1997). Swartz and Keenan (2001) revealed that affordability affects for implementation micro insurance. Based on them, the researcher advanced the third alternative hypothesis as there is a significant impact of affordability on the implementation micro insurance. A simple linear regression test tested the hypothesis. Standardized Coefficients Beta value of affordability is 0.206 and it is a positive value and Sig. = .000. The results are similar to the results of past researches (Litman, 1997; Ku & Ross, 2002; Swartz & Keenan, 2001).

The researcher found a positive impact of consumer trust on income on implementation micro insurance with the support of literature. It is possible that raising the trust perception will enhance the sale of micro insurance (Urban et al, 2000). Calnan and Sanford (2004) found that fundamentals including age, ethnic group, health conditions, and private insurance coverage are drivers of trust in their study. Insurance firms are always ready to supply dependable micro insurance plans to clients who pay regular premiums, and individuals feel that when they are faced with risks, they will receive claim payouts on time (Loewe, 2006). Based on them, the researcher advanced the third alternative hypothesis as there is a significant impact of consumer trust on income on implementation micro insurance. Standardized Coefficients Beta value of consumer trust on income is 0.240 and it is a positive value and Sig. = .000. Accordingly, there is a positive impact of consumer trust on income

implementation micro insurance. The results are similar to the results of past researches (Calnan & Sanford, 2004; Loewe, 2006; & Urban et al, 2000).

## **5. Conclusion**

Micro insurance is becoming a popular concept all around the world but it seemingly lacks in Sri Lankan context, especially among the self-employed people and there is no clear evidence what are barriers causing this that is issue this research paper addressed. Therefore, researcher investigated the impact of the so-called barriers to micro insurance. The researcher used the sample of Self-employed people. The researcher executed the study as a cross-sectional study under the quantitative method. Four hypotheses were advanced with the support of past literature. Google forms were shared 450 and among them, 123 responses were used to analyze the data.

Finally, all the hypotheses were accepted and study found that willingness to pay, accessibility, accessibility and affordability affect on the implementation of Micro insurance in Sri Lanka. There are significant implications from this research paper. The present study developed the model to test the impact of four barriers to implementing micro insurance facilities for self-employment persons. To the best of the researcher's knowledge, there are very few academic works is conducted to find the barriers to implementing micro insurance schemes. Accordingly, the lack of academic research on this topic raises an interesting question for management scholars. As well there are still limited research and academic literature related to Insurance Industry. Hence, this research helps to tie the gap in the context with more empirical validations in future. Thus, this study contributes to this knowledge domain.

This study produces several implications for industry professionals and the insurance company. The finding of



this study is useful for identifying the barriers to implementing the micro insurance barriers for self-employed persons. Through this, insurance companies can introduce new eye-catching insurance schemes to eliminate or mitigate the impact of these barriers and also industry professionals able to identify the new markets and develop their marketing strategies. The sample of this study was Kurunagala district only. Hence, future researchers can be tested covering a wider sample who are engaged in self-employment. Future researchers can conduct longitudinal research to do an in-depth analysis regarding the problem and validate the findings of the present study.

## **6. References**

- Ahuja, R., & Guha-Khasnobis, B. (2005). Micro-insurance in India: trends and strategies for further extension (No. 162). Working Paper.
- Ahuja, R., & Jütting, J. (2004). Are the poor too poor to demand health insurance? (No. 118). Working paper.
- Balkenhol, B., & Churchill, C. (2002). From microfinance to micro health insurance. *Social reinsurance*, 75.
- Biener, C. (2013). Pricing in microinsurance markets. *World Development*, 41, 132-144.
- Calnan, M. W., & Sanford, E. (2004). Public trust in health care: the system or the doctor?. *BMJ Quality & Safety*, 13(2), 92-97
- Cohen, M., & Sebstad, J. (2005). Reducing vulnerability: The demand for microinsurance. *Journal of International Development: The Journal of the Development Studies Association*, 17(3), 397-474.

Churchill, C. (2006) *Protecting the Poor: A Micro insurance Compendium*. Geneva: ILO. (2007).

Czura, K., & Dequiedt, V. (2015). Willingness-to-pay for microinsurance and flexibility: Evidence from an agricultural investment lab-in-the-field experiment in Senegal.

Dror, D. M., Radermacher, R., & Koren, R. (2007). Willingness to pay for health insurance among rural and poor persons: Field evidence from seven micro health insurance units in India. *Health policy*, 82(1), 12-27.

Hair Jr, J. F., Sarstedt, M., Hopkins, L., & Kuppelwieser, V. G. (2014). Partial least squares structural equation modeling (PLS-SEM): An emerging tool in business research. *European business review*. Huber, C., & Schlager, T. (2011). To buy or not to buy insurance? The antecedents in the decisionmaking process and the influence of consumer attitudes and perceptions. *Working Papers on Risk Management and Insurance*, 90, 136-175

Jacquier, C., Ramm, G., Marcadent, P., & Schmitt-Diabaté, V. (2006). Chapter 1.3: The social protection perspective on micro-insurance. *Protecting the poor: A micro-insurance compendium*. Geneva.

Kothari, C. R. (2004). *Research methodology: Methods and techniques*. New Age International.

Kousky, C., & Kunreuther, H. (2014). Addressing affordability in the national flood insurance program. *Journal of Extreme Events*, 1(01), 1450001.

Litman, T. (1997). Distance-based vehicle insurance as a TDM strategy. *Transportation Quarterly*, 51, 119-137.

Linnerooth-Bayer, J., Mechler, R., & Pflug, G. (2005). Refocusing disaster aid. *Science*, 309(5737), 1044-1046.

Linnerooth-Bayer, J., & Mechler, R. (2006). Insurance for assisting adaptation to climate change in developing countries: a proposed strategy. *Climate policy*, 6(6), 621-636.

Llanto, G. M. (2007). Policy and regulatory issues and challenges in microinsurance: A Philippine case. *Philippine*

*Journal of Development*, 34(1), 61-86.

Loewe, M. (2006). Downscaling, Upgrading or Linking? Ways to Realize Micro-Insurance. *International Social Security Review*, 59(2), 37-59.

Lashley, J. G., & Warner, K. (2015). Evidence of demand for microinsurance for coping and adaptation to weather extremes in the Caribbean. *Climatic Change*, 133(1), 101-112.

Ma, J., & Orgun, M. A. (2006). Trust management and trust theory revision. *IEEE Transactions on Systems, Man, and Cybernetics-Part A: Systems and Humans*, 36(3), 451-460.

McCord, M. J., Ramm, G., & McGuinness, E. (2006). Microinsurance. Demand and market prospects, Study Commissioned by Allianz, GTZ, UNDP.

Morduch, J. (2006). Microinsurance: The next revolution. *Understanding poverty*, 337-356.

Hodge, D. R., & Gillespie, D. (2003). Phrase completions: An alternative to Likert scales. *Social Work Research*, 27(1), 45-55.

Schneider, P., & Diop, F. (2004). Community-based health insurance in Rwanda. *Health financing for poor people—Resource mobilization and risk sharing*, Washington DC: World Bank, 251-274.

Swartz, K., & Keenan, P. S. (2001). *Healthy New York: Making Insurance More Affordable for Low-Income Workers*. Commonwealth Fund.

Taylor, S. A. (2001). Assessing the use of regression analysis in examining service recovery in the insurance industry: Relating service quality, customer satisfaction, and customer trust. *Journal of Insurance Issues*, 30-57.

Urban, G. L., Sultan, F., & Qualls, W. J. (2000). Placing trust at the center of your Internet strategy. *Sloan*

*Management Review*, 42(1), 39-48.

Wiedmaier-Pfister, M., & Wohlner, E. (2004). Microinsurance Sector Study: Sri Lanka. Deutsche Gesellschaft für Technische Zusammenarbeit (GTZ), Division 41.

Wang, H., Yip, W., Zhang, L., Wang, L., & Hsiao, W. (2005). Community-based health insurance in poor rural China: the distribution of net benefits. *Health policy and planning*, 20(6), 366-374.

## THE IMPACT OF RISK MANAGEMENT ON THE FINANCIAL PERFORMANCE OF LISTED INSURANCE COMPANIES IN SRI LANKA

Supun Nishan K.<sup>1</sup> and Fernando. J.M.B.R<sup>2</sup>

### Abstract

**Introduction:** Risk, if not adequately managed, can lead to the demise of most businesses, particularly those whose core business is risk management on a day-to-day basis. Risk management should therefore be at the heart of an organization's operations, with risk management techniques integrated throughout the whole organization's processes, systems, and culture. Thus, the goal of this research is to determine the impact of risk management strategies used by Sri Lankan insurance companies on their financial performance.

**Design/Methodology/Approach** - The study employed an exploratory research design, with 28 registered insurance companies in Sri Lanka as the target population. Secondary data was employed in the study. 15 insurance companies were contacted for secondary data. Secondary data was gathered over a six-year period from 2015 to 2020 using published sources as well as data from IRCSL's financial statements. Panel regression analysis was used in the research. Underwriting risk, market risk, liquidity risk, and operational risk were used as proxies for risk management whereas the return on asset is the proxy for financial performance. The firm size was used as a moderating variable and the type of insurance as the control variable.

**Findings** – Underwriting risk, market risk, and operational risk showed a significant and positive relationship with the return on assets ratio and the moderating effect of firm size on the relationship between liquidity and financial performance also show a positive and significant impact. Liquidity risk showed a significant negative relationship with the return on assets.

**Conclusion** – The study suggests that Sri Lanka's listed insurance companies should consider reducing their costs and claims through appropriate estimating pricing and valuation techniques. Furthermore, insurance companies should provide sufficient diversification of the insurance policy portfolio in order to earn higher premiums that can cover other losses when they occur. The findings imply that good management of a firm's operations results in lower operating expenses, which leads to an increase in the proportion of net premiums to total assets, which improves a firm's performance. To cut expenses and improve financial performance, insurance companies should employ efficient operations management procedures.

**Keywords:** *Risk management, Risk factors, Insurance industry, Financial performances.*

**Cite this paper as:**

Supun Nishan K. (2022). THE IMPACT OF RISK MANAGEMENT ON THE FINANCIAL PERFORMANCE OF LISTED INSURANCE COMPANIES IN SRI LANKA. 10th Students' Research Symposium, Department of Finance, University of Kelaniya, Sri Lanka. 2. 32-53

<sup>1</sup>Department of Finance, Faculty of Commerce and Management Studies, University of Kelaniya  
([Supunnishan19@gmail.com](mailto:Supunnishan19@gmail.com))

<sup>2</sup>Department of Finance, Faculty of Commerce and Management Studies, University of Kelaniya

## 1. Introduction

Financial intermediaries play a positive role in the economic growth of a country (Hardwick & Adams, 2002). In an economy, financial services are provided by various financial institutions through different types of instruments (Liargovas & Skandalis, 2010). Therefore, financial service is one of the important pillars of a financial system (Hardwick & Adams, 2002). As a financial service, insurance contributes to the growth and development of every economy by providing unique financial services such as underwriting risk inherent in economic entities and mobilization of a large amount of funding through premiums of long-term investments (Malik, 2011).

The risk absorption role of insurance promotes financial stability in the financial market and provides a “sense of peace” to economic entities (Hardwick & Adams, 2002). Since risky businesses may not have the capacity to retain all kinds of risk in this ever-changing and uncertain global economy, the business world is unsustainable without insurance (Malik, 2011). Therefore, insurance is referred to as the backbone of managing the risk of the country (malik, 2011). The insurance provides a diverse insurance product to organizations and individuals, providing safety from risk thereby ensuring financial security (Liargovas & Skandalis, 2010). In here, insurance companies maximize their shareholders’ value based on their capacity to cover the risk in the economy (Ahmed, 2011).

Insurance companies contribute to the stability of the financial system in particular and the stability of the economy of the concerned country (Molyneux, 1992). Therefore, in general, insurance is considered a part of the

immune and repair system of the economy (Molyneux, 1992). Insurance companies give important service to both individuals and businesses as they channel funds and indemnify the losses of other sectors in the economy and put them in the same position as they were before the occurrence of the loss respectively (Malik, 2011). In addition, insurance companies provide economic and social benefits to society by preventing of losses, reduction in anxiousness, fear, and increasing employment (Ahmed, 2011).

Customer retention and cost-effectiveness have become increasingly important as the market rivalry has increased, requiring insurance businesses to look for ways to enhance sales and customer happiness while keeping costs low and sustaining profitability. As a result, new alternative distribution channels, such as online platforms, mobile applications, and social media, have emerged, enabling premium growth at lower costs.

The uncertainty connected with a future outcome or event is known as risk (Banks, 2004). Furthermore, the risk is a term that refers to the possibility of a negative influence on an asset or a value feature as a result of a current process or a future event (Wildavsky, 1982). According to Rejda (2008), Risk management is the process by which an organization discovers loss exposures and chooses the most appropriate approaches for handling such exposures.

A priority approach must be followed in risk management, with the risk with the largest loss and greatest probability of occurrence being dealt with first and risks with the lower loss being dealt with later (Stulz, 2003). However, there is no single paradigm for determining risk management is complicated by the need to strike a balance between risks with the highest potential of loss and those with lesser losses. According to Banks (2004),



the primary goal of risk management is to regulate, rather than eliminate, risk exposures so that all stakeholders are fully aware of how the organization may be harmed. In general, a good risk management approach allows a company to lower its risk exposure and prepare for unforeseen events.

There are various kind of risk factors that affect the financial performance of an insurance company such as underwriting risk, marketing risk, liquidity risk, operational risk. Therefore, it requires empirical investigation to sort out what are the important factors affecting the profitability of insurance companies and will facilitate the governing bodies to focus on the relevant factors. According to the previous studies, many researches have been conducted to identify the relationship between the performance of various institutes (such as manufacturing companies, banks, agriculture companies etc.) and different factors.

Profitability, solvency, and liquidity are all factors that can be used to evaluate a company's financial success. Financial performance can be monitored by monitoring the firm's profitability levels. According to Soreriou and Zenios (1999), profitability analysis employs profitability ratios to focus on the relationship between revenues and expenses, as well as the number of earnings relative to the size of the investment in the business. The common measurements of profitability are; return on equity (ROE) and return on assets (ROA). It is possible to assess a company's financial health by keeping track of its profitability levels. Some risks, according to Stulz (2003), present possibilities for a corporation to gain comparative advantages and improve its financial performance literature suggests that better risk management practices lead to the increased financial performance of companies. Insurance companies can better comprehend the advantages of establishing a risk

management strategy by integrating risk management and performance.

In 2011, Wharton School conducted a study that found a link between the maturity of a company's risk management system and its financial performance. For most organizations, better risk maturity is associated with improved ROA and stock performance, Ernst and Young (2012) bolsters this argument by claiming that organizations with more mature risk management procedures outperform their rivals financially and create the most revenue growth.

In Sri Lanka, the insurance sectors have reacted to the growth of the Sri Lankan economy as other sectors such as banking. The following highlighted conditions represent such growth, the insurance industry has grown at about 8.64% in a market through the year 2019 and the was sufficient growth for the economy. Because the major goal of financial management is to maximize the owner's wealth and profitability, profitability is one of the most important objectives of financial management (Frank Nguyen, 2006). But because of COVID 19, premium growth in emerging markets has become positive in both years, increasing by 1% in 2020 and 7% in 2021. In Europe and North America, however, insurers are still in the midst of the storm, trying to figure out how to survive and what business as usual looks like in unusual circumstances. COVID-19 will continue to pose a financial threat to the insurance business, resulting in pandemic-related losses, reduced investments, and losses on invested assets. However, certain common elements are beginning to emerge for insurers all around the world as they work to overcome these uncertainties.

The subject of financial performance has received significant attention from scholars in the various areas of

business and strategic management ( Liargovas & Skandalis, 2010). It has also been the primary concern of business practitioners in all types of organizations since financial performance has implications for an organization's health and ultimately its survival (Liargovas & Skandalis, 2010).

Risk management has traditionally been focused on controlling and ensuring regulatory compliance rather than improving financial performance (Bank, 2004). Risk management, on the other hand, frequently leads to improved financial performance since regulatory compliance and risk control allow the firm to save money. Bank (2004) emphasized that through controlling risks, managers are able to raise the firm's value while assuring its continuous profitability. Therefore, the current study investigates the effect of risk management on the financial performance of listed insurance companies in Sri Lanka. Thus, this study examines the effect of different categories, underwriting risk, market risk, liquidity risk, and operational risk on the financial performances of the listed insurance companies in Sri Lanka.

## **2. Literature review**

Insurance is a risk transfer mechanism that ensures full or partial financial composition for the loss or damage. According to the investigation of the (Malik, 2011), insurance fulfils a significant role in promoting commercial and infrastructural business. From the latest perspective, it enhances financial and social stability, mobilizes and channels saving, supports trade, commercial and entrepreneurial activity and improves the quality of the lives of individuals, organizations, and the overall wellbeing in a county.

Studies have identified that insurance companies are playing the role of transferring risk channelling funds from one unit to the other (financial intermediation) such as general insurance companies and life insurance companies respectively. The notion of risk management theory entails investigating the many methods through which corporations and people acquire funds, as well as how funds are distributed to projects while taking into account the risks involved. The agency theory, stakeholders' theory, and optimal capital structure theory are the theories discussed in this section.

Anshoria (2007) defines performance as the organization's ability to acquire and manage resources in a variety of ways in order to build a competitive advantage. As with any company, profitability is a key determinant for deciding whether to invest. There are two profit margins to consider for an insurance company: premium / underwriting income and investment income Babbel and Santomero (1997). Underwriting income is any revenue derived from issuing insurance policies. By averaging the premium's growth rates of several past years, you can determine the growth trends. Risk management factors can have a positive or negative impact on a company's financial performance. The following are the empirical finding investigated by different researchers (both academicians and practitioners).

Empirical literature shows how risk management factors have an effect on the performance of the companies, such as Underwriting risk, Market risk, Operational risk, Liquidity risk, Firm size, and Type of insurance. For this study, these factors have been selected because they are the most appropriate ones for the Sri Lanka context, among many factors affecting the financial performance of insurance companies. A swell as these factors can be

easily measured by using the data that is afforded by the financial statement of the insurance companies in Sri Lanka.

### **3. Methodology**

The main objective of this study is to explore the impact of risk management parameters on the performance of Sri Lankan listed insurance companies. The population, sample, data collection method, and data analysis method are all key topics discussed in the explanation. The defining of essential variables, the conceptual model, the development of hypotheses, and operationalization are all explored.

### 3.1. Conceptual Framework

Figure 3.1.1: Conceptual Framework

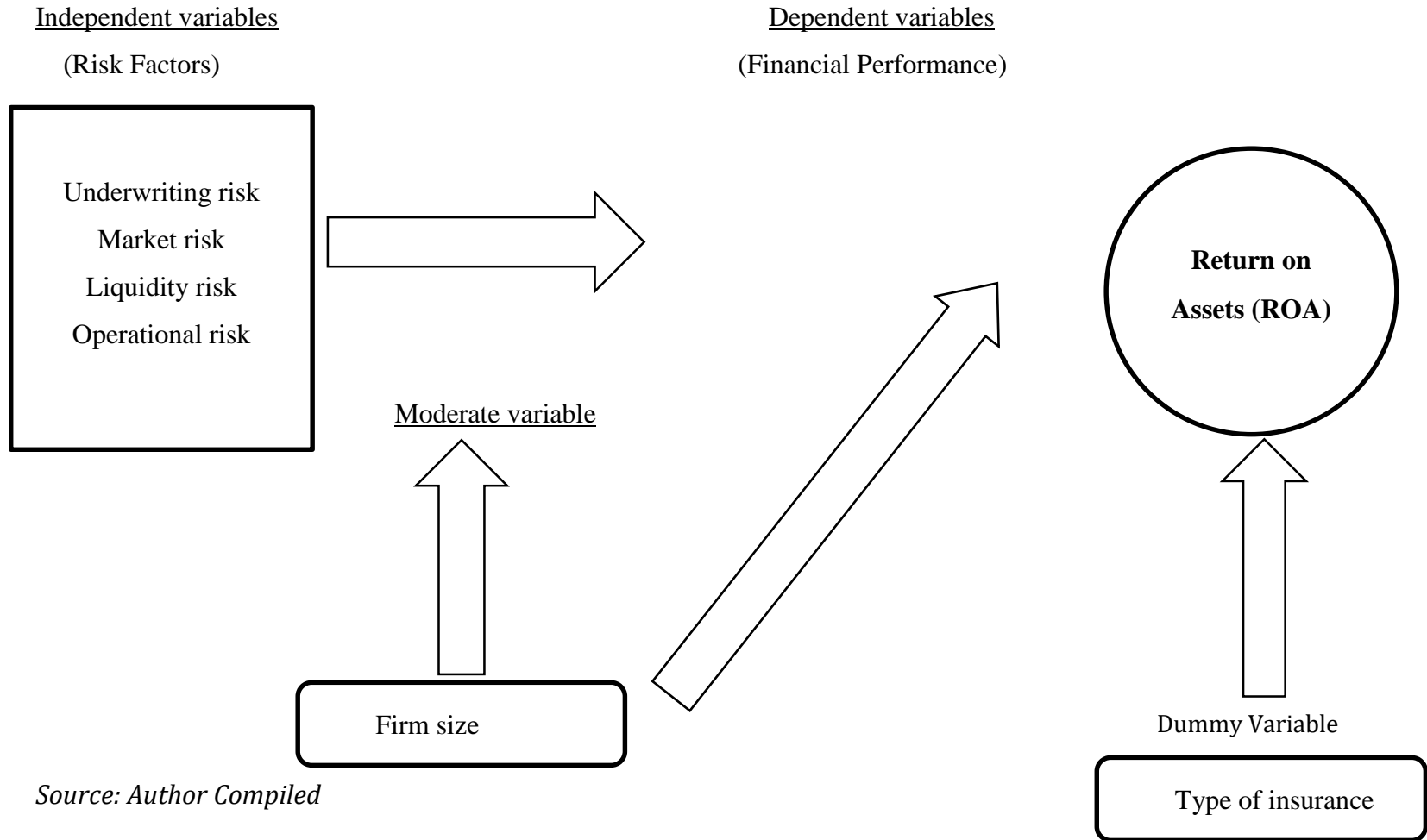

Source: Author Compiled

### 3.2. Hypotheses testing

The study has formulated the following hypotheses to achieve the objectives of the study.

H<sub>1</sub>: There is a significant impact of underwriting risk, market risk, liquidity risk, operational risk, firm size on the financial performance of listed insurance companies.

H<sub>2</sub>: firm size moderate the relationship between underwriting risk, market risk, liquidity risk, operational risk, firm size and the financial performance of listed insurance companies.

### 3.3. Regression analysis

The goal of this type of analysis is usually to forecast or estimate the value of one variable based on the value of another variable. The regression influence between the dependent and independent variables can be formulated in this study. A basic linear regression will be provided by this model. As a result, it was expected in this research that the independent variables would have a linear connection with the other variables. One goal of regression analysis is to come up with a strategy for predicting the dependent variable's value. The regression model always indicates by how much the independent variable would affect the dependent variable. A linear regression was performed to investigate the degree of impact of risk management parameters on insurance company performance. The "dependent variable" is return on assets (ROA), whereas the "independent variables" are underwriting ratio, market ratio, liquidity ratio, and operational ratio. The significance of the coefficient was

determined using the 'P' value. The following is a representation of a linear regression model.

$$ROA = \beta_0 + \beta_1(UW) + \beta_2(MK) + \beta_3(LQ) + \beta_4(OP) + \beta_5(FS) + \beta_6(TY. In) + \beta_7(Uw*fs) + \beta_8(Mk*fs) + \beta_9(Lq*fs) + \beta_{10}(Op*fs) + e - \text{Equation 01}$$

### 3.4. Operationalization

Table 3.4.1: Operationalization

VARIABLE	MEASURES	SOUECES
Underwriting risk (UW)	<u>underwriting and net acquisition expenses</u> Earned premium	(BaahAyeKusi, 2019 )
Marketing risk (MK)	<u>profit after tax</u> Ordinary shares on issue	(Isaac Kibet Kiptoo, 2021 )
Liquidity risk (LQ)	<u>Current assets</u> Current liability	(OMASETE, 2014)
Operational risk (OP)	<u>Net earned premiums</u> Total assets	(Isaac Kibet Kiptoo, 2021 )
Size (FS)	Log of total assets	(BaahAyeKusi, 2019 )
Return on Assets	<u>Net profit after tax</u> Total assets	(malik, 2011)
Type of insurance	General and life insurance	(IRCSL, 2018)



(Dummy variable)

---

*Source: Author Compiled*

---

### 3.5. Data, Data Collection Method & Study Period

A research technique is a systematic and ordered approach to data collecting and analysis. A data collection was used in this investigation. Secondary sources will be used to get information. The study's time frame is the most recent five years, commencing in 2015 and ending in 2020. The data were collected from, published annual reports of selected listed insurance companies during the 06-year period between 2015 and 2022 and from published reports of the insurance regulatory commission of Sri Lank (IRCSL)

## 4. Results and discussion

Table 4.1: Descriptive statistics

Variable	Mean	Std. Dev.	Minimum	Maximum
Uw risk	0.1638889	0.1434541	0.02	0.62
Mk risk	13.31422	17.41645	0.07	70.99
Lq risk	1.453667	1.370571	0.13	9.06
Op risk	0.3466667	0.1718635	0.02	0.8
Firm size	19.16967	8.014111	13.96	50.41
TY.IN (dummy)	0.7111111	0.4557854	0	1

ROA	0.1882222	0.1747716	0.01	0.68
-----	-----------	-----------	------	------

*Source: Author Compiled*

Table 4.1 shows, the descriptive statistics for all variables, including response and explanatory factors. The descriptive statistics are based on 06-year data from 15 insurance firms with 90 observations. The average (mean) profitability as evaluated by ROA is about 18.82% and the standard deviation for ROA is about 17.47%, implying that there are large differences in profitability values across the insurance companies included in this study. The minimum value of ROA is 1% and the maximum value is 68%, indicating that the selected sample contains both low-profit-making and high-profit-making enterprises. In six years the mean value of underwriting risk is 0.16 and the standard deviation is 0.14. the minimum value of underwriting risk is 0.02 and the maximum value 0.62. The market risk has a mean value of 13.31 and a standard deviation of 17.41. Furthermore, the minimum value of 0.07 and maximum value of 70.99 illustrate that there is a large range between the market ratio values. The liquidity ratio has a mean value of 1.45 and a standard deviation of 1.37. Furthermore, the minimum value of 0.13 and maximum value of 9.06 illustrate that there is a large range between the liquidity ratio values, and working capital management policies may differ from insurance companies with high liquidity ratios. The mean value of the operational risk is 0.34. there are significant differences between the operational values, as shown in the table. the standard deviation value is 0.17 and operational risk maximum value is 0.80 and the minimum value is 0.02. Size has a mean value of 19.16. As can be seen in the table above, there is significant diversity in size among the sample insurance businesses, owing to the fact that the standard deviation is 8.01,

indicating that both medium and large companies are included in the sample.

Table 4.2: Correlation matrix

Variable	Uw risk	Mk risk	Lq risk	Op risk	Firm size	Ty.in (d.v.)	ROA
Uw risk	1.0000						
Mk risk	0.2736	1.0000					
Lq risk	-0.0335	-0.1308	1.0000				
Op risk	0.0305	-0.1675	0.1897	1.0000			
Firm size	-0.2533	-0.2017	-0.0841	0.0529	1.0000		
TY. IN (d. v.)	-0.1940	-0.2850	-0.0431	-0.4973	-0.2972	1.0000	
ROA	0.0796	-0.2823	0.1598	0.1241	0.2206	0.0175	1.000

*Source: Author Compiled*

The company underwriting risk was positive and correlated with returns on assets and correlated significantly with the coefficient of 0.0796 at a significant level of 1%. The company market risk, was negative and correlated with returns on assets and correlated significantly with the coefficient of -0.2823 at a significant level of 1%. The company liquidity risk was positive and correlated with returns on assets and correlated significantly with the coefficient of 0.1598 at a significant level of 1%. The companies' operational risk was positive and correlated with

returns on assets and correlated significantly with the coefficient of 0.1241 at a significant level of 1%. The firm size was positive and correlated with returns on assets and correlated significantly with the coefficient of 0.2206 at a significant level of 1%. The type of insurance was positive and correlated with returns on assets and correlated significantly with the coefficient of 0.0175 at a significant level of 1%.

Table 4.3: Empirical model testing

---



---

Test: Ho: difference in coefficients not systematic

$$\text{Chi2}(0) = (b-B)'[v_b-v_B]^{-1}(b-B)$$

Prob. >chi2 = 0.000

---



---

*Source: Author Compiled*

The likelihood value is less than the 0.05 level, based on the above results. As a result of the Hausman test, the null hypothesis that the random effect model is acceptable was rejected, and the alternative hypothesis that the fixed-effect model is appropriate was accepted. As a result, the analysis shows the results of the fixed-effect model.

Table 4.4: Results of the panel regression

---



---

Variable	coefficient	Std. error	t-statistic	Prob.
C	0.492173	0.2503352	1.97	0.054
Uw risk	1.020822	0.3471135	2.94	0.005

---



---

Mk risk	0. 0065261	0. 0019394	3. 37	0. 001
Lq risk	-0. 1722759	0. 0505672	-3. 41	0. 001
Op risk	0. 3477536	0. 1715833	2. 03	0. 047
Firm size	-0. 0064928	0. 0137059	-0. 47	0. 637
TY.IN (d.v)	-0. 4246178	0. 0774227	-5. 48	0. 000
Uw*fs	-0. 0276096	0. 0191697	-1. 44	0. 155
Mk*fs	-0. 0002945	0. 0001034	-2. 85	0. 006
Lq*fs	0. 0098871	0. 0030379	3. 25	0. 002
Op*fs	-0. 0164727	0. 0129983	-1. 27	0. 210

*Source: Author Compiled*

The statistical significance of the three hypotheses was determined using panel multiple regression at the 95 percent confidence level ( $\alpha = 0.05$ ) and 90 percent confidence level ( $\alpha = 0.10$ ). When considering the corporate underwriting, the above table shows the coefficient of 1.0208 and the probability is 0.005. The results indicate that underwriting risk positively and significantly effect on insurance firm's performances. Considering the market risk, the coefficient is 0.0065 and the probability is 0.001, indicating a positive and significant impact. Liquidity risk is negatively affect with the coefficient of -0.1722 and the likelihood is 0.001. The operational risk positively and significantly effects on the insurance firm profitability, the coefficient is 0.3477 and the probability is 0.047 in this table. Considering the corporate firm size, the coefficient is -0.0064 and the probability is 0.637. The moderate effect of firm size on the relationship between underwriting risk and firm performances the coefficient is -0.0276 and the likelihood is 0.155, indicating an insignificant impact. In contrast, the moderate

effect of firm size on the relationship between market risk and firm performances is significant coefficient at 5% significant level. The moderate effect of firm size on the relationship between liquidity and firm performances also significant at 5% level. However, the moderate effect of firm size on the relationship between operational risk and firm performances is not significant.

The underwriting risk probability value is 0.005, which is less than 0.05. that is The findings revealed that underwriting risk has a positive significant impact on the return on assets of commercial and service enterprises listed in Sri Lanka. As a result, at a 5% level of significance, the hypothesis that underwriting risk had significant effect on return on asset of commercial and service enterprises in Sri Lanka was accept. The market risk probability value is 0.001, which is less than 0.05. that is The findings revealed that market risk has a positive significant impact on the return on assets of commercial and service enterprises listed in Sri Lanka. As a result, at a 5% level of significance, the hypothesis that market risk had significant effect on return on asset of commercial and service enterprises in Sri Lanka was accept. The liquidity risk coefficient is -0.1722, which is statistically significant with a p-value of 0.001, which is less than 0.05. The findings revealed that liquidity risk has a significant negative impact on the return on equity of commercial and service enterprises listed in Sri Lanka. As a result, at a 5% level of significance, the null hypothesis that liquidity risk had no significant effect on return on asset of commercial and service enterprises in Sri Lanka was rejected. (Susan Kerubo Onsongo). The operational risk coefficient was ( $\beta = 0.34775$ ,  $p = 0.047 < 0.05$ ). The findings revealed that operational risk had a statistically significant beneficial effect on the return on equity of Sri Lankan listed insurance companies. According to the findings on operational risk, an increase in operational risk led to an increase in firm performance as measured by

ROA. The firm size probability value is 0.047, which is less than 0.05. that is The findings revealed that firm size has a positive significant impact on the return on assets of commercial and service enterprises listed in Sri Lanka. As a result, at a 5% level of significance, the hypothesis that firm size had a significant effect on return on asset of commercial and service enterprises in Sri Lanka was accept. The interaction between firm size with market risk and liquidity risk are significant. Accordingly, the all the selected independent variables show an impact on the financial performances of the insurance companies except the firm size, however, firm size has a moderate effect only with the relationship between market and liquidity risk financial performances of the insurance companies.

## **5. Conclusion**

The impact of risk factors on insurance company performance was investigated in this study. As a result, the researcher examined the impact of risk variables on insurance businesses' financial performance using a variety of parameters. As a result, underwriting risk, marketing risk, liquidity risk, operational risk, firm size, moderate variable and kind of insurance are all important elements affecting insurance company success in Sri Lanka. For the analysis, 15 companies in the listed insurance industry were included in the study. Descriptive statistics such as correlation analysis, hausman test, and regression have been used to investigate the impact of risk variables on financial performance. According to the findings, underwriting risk, market risk, and operational risk all have a positive and significant impact on the profitability of insurance businesses in Sri Lanka. Liquidity risk show a negative and significant impact on the profitability of insurance businesses in Sri Lanka, whereas the size of the

firm as a moderate variable affect the financial performance via market risk and liquidity risk.

This study made the following recommendations based on the findings of the retrospective analysis. The study discovered that underwriting risk has a significant impact on the performance of listed insurance companies. As a result, Sri Lanka's listed insurance companies should consider reducing their costs and claims through appropriate estimating pricing and valuation technology, while taking into account the risk of specific sectors and catastrophic events. At the same time, they must charge a reasonable premium for insurance policies that provide extensive coverage. Furthermore, insurance companies should provide sufficient diversification of the insurance policy portfolio in order to earn higher premiums that can cover other losses when they occur. As a result, Sri Lanka's listed companies should pay close attention to these areas in order to reduce the risk of reinsurance for their performance. Market risk management has a positive and significant impact on financial performance, according to the findings. According to the data, effective investment selections raise the proportion of investment income to average investments, resulting in improved financial performance. To improve performance, insurance companies should guarantee that their investments are properly managed. According to the findings, liquidity risk has a significant impact on the performance of listed insurance companies. As a result, insurance companies should consider diversifying their investment portfolio by investing their passive funds in a variety of industries. As a result, listed insurance companies should properly implement this order by developing and implementing an appropriate investment portfolio management strategy that can boost their returns. The



findings imply that good management of a firm's operations results in lower operating expenses, which leads to an increase in the proportion of net premiums to total assets, which improves a firm's performance. To cut expenses and improve financial performance, insurance companies should employ efficient operations management procedures. Future studies could expand the empirical model by considering more risk categories and the sample size. Furthermore, more research into the general insurance business might be also interested in the same area of study.

## **6. References**

- Ahmed, n. (2011). Determinants of performance: A case of life insurance sector of Pakistan. researchgate, 123-128.
- Anshoria, I. a. (2007). Factors Affecting the Financial Performance of. Journal of Management Research.
- BaahAyeKusi, A. D.-S. (2019 ). Insuranceregulations,riskand performanceinGhana. JournaloffinancialRegulation andComplianc, 74-96.
- Babbel, D. F., & M. Santomero, A. (1997). Risk Management by Insurers: An Analysis of the Process. 96.
- Hardwick, P., & Adams, M. (2002). The Determinants of Financial Derivatives Use in the United Kingdom Life Insurance Industry. ResearchGate, 163-184.
- Isaac Kibet Kiptoo, S. N. (2021 ). Risk management and financial performance of insurance firms in Kenya. Cogent Business & Management , 1-17.
- Liargovas, p., & Skandalis. K.S. (2010). Factors Affecting Firms'™ Financial Performance: The Case of Greece. researchgate.

Malik, H. (2011). DETERMINANTS OF INSURANCE COMPANIES PROFITABILITY: AN ANALYSIS OF INSURANCE SECTOR OF PAKISTAN.

Molyneux, p. (1992). Determinants of European bank profitability.

Omasete, C. A. (2014). THE EFFECT OF RISK MANAGEMENT ON FINANCIAL PERFORMANCE OF INSURANCE COMPANIES IN KENYA . 1-15.

Rejda, G. E. (2008). Principles of Risk Management and Insurance, 10th Edition.

Soreriou, a. c., & zenios, s. (1999). Operations, Quality, and Profitability in the Provision of Banking Services. researchgate.

Stulz, R. (2003). Risk Management and Derivatives. scientific research.

Susan Kerubo Onsongo, S. M. (n.d.). Financial Risk and Financial Performance: Evidence and Insights from Commercial and Services Listed Companies in Nairobi Securities Exchange, Kenya. international journal of financial studies.

Wildavsky, M. D. (1982). Risk and Culture. Journal of policy analysis and management , 303-309.

## A STUDY OF AWARENESS AND USAGE OF E-BANKING SERVICES AMONG WOMEN WITH SPECIAL REFERENCE TO KUNDASALE DIVISION, KANDY

Athukorala A.A.M.<sup>1</sup> and Samarawikrama A.J.P<sup>2</sup>

### Abstract

**Introduction-** This research study investigates the awareness and usage of e-banking services among women in Kundasale Division, Kandy District.

**Design/Methodology/Approach-** For this purpose, nine hypotheses were proposed and tested. In this study, Usage of e-banking services is measured by the eight components; Demographic factors, awareness, convenience, security, cost effective, perceived risk, attitude, Knowledge and accessibility. More over researcher has examined the impact of demographic factors to the awareness to e-banking services. Sample size comprises of 214 respondents from women who lived in Kundasale division, Kandy District. Sample was selected using convenience sampling technique and data was collected through primary sources. To collect the primary data, questionnaire was used. The statistical methods of Regression analysis were used for the testing of the research hypotheses.

**Findings-** Results revealed demographic factors, convenience, attitude, knowledge and accessibility and security, cost effective and perceived risk has insignificant impact on usage of e-banking services among women. Also, the women demographic factors have significant impact on the awareness of e-banking services.

**Conclusion-** The final results emphasize that the overall model for demographic and awareness and usage of e-banking services has significant impact on the usage and awareness of e-banking services among women and out of this demographic factors only marital status examined the insignificant and when considering factors affects only three factors (convenience, attitude, knowledge and accessibility) were significant while security, cost effective and perceived risk were not significantly impact on the awareness and usage of e-banking services among women in Kundasale Division, Kandy.

**Keywords:** *e-banking, women, awareness and usage, Kundasale division*

#### Cite this paper as:

Athukorala A.A.M. and Samarawikrama A.J.P. (2022). A STUDY OF AWARENESS AND USAGE OF E-BANKING SERVICES AMONG WOMEN WITH SPECIAL REFERENCE TO KUNDASALE DIVISION, KANDY. *10<sup>th</sup> Students' Research Symposium, Department of Finance, University of Kelaniya, Sri Lanka*. 3. 54-80

<sup>1</sup>Department of Finance, Faculty of Commerce and Management Studies, University of Kelaniya (apekshaathukorala96@gmail.com)

<sup>2</sup>Department of Finance, Faculty of Commerce and Management Studies, University of Kelaniya

## 1. Introduction

The banking sector which directly related with the Sri Lankan financial system plays a significant role in Sri Lankan economic context which contribute to country's development. Banks are the major liquidity providers for the economy while transforming the risk characteristics of their assets. Bank is a place where which accepting money for the purpose of lending or investment, of deposits of money from the public, repayable on demand and withdrawal by cheque, draft or otherwise. Banking sector is the basis of every country's financial sector where all the economic activities operate around it.

E-banking is a fully automatic service where replace the traditional banking operations to electronical based. It provides customer access to their accounts, the ability to transfer their money between different accounts or making payments via e-channels. The advantages generated by these services have determined an accelerate developing of banking industry over the entire world (Elizabeth, 2000) In Sri Lanka, e-banking was first introduced by the Sampath Bank in 1988.They started with networking all their branches enabling their customers to access to their accounts at any branch (Jayasiri et al., 2016) . Aggarwal (2018), said the Sri Lankan leading state bank where second largest customer base after Bank of Ceylon; People's bank, has undertaken a comprehensive and multi-pronged digital programme, achieving 80% digital onboarding, a strong uptake of its mobile banking and digital transactions. There is more than hundred percentage of increasing of both mobile banking and digital transaction growth even with a one-year period where 261% growth in mobile banking and

348% in digital transaction growth.

In information processing male and female use different socially constructed cognitive structures when turn them towards perceptions (Viswanath Vankatesh, 2000). Females are believed to be disadvantaged compared to their male counterparts with respect to using IT innovations and applications. When considering Nagaraj & Jegatheeswari (2016) study she interprets that the major respond is from male which is 64.66 % while female responds as 35.33% this clearly shows that there is huge gap between male and female considering responding to the questioner on e-banking. Therefore, to study female awareness is necessary to measure isolate, which means it is essential to interview women apart from male. And also, there is majority of research done as taking the respond common to male and female so many them are not even mentioned the percentage of each gender participation. Also, the research study supports to fill the literature gap exist in local level. Furthermore, there is a very little number which can be countable relating to this research area in published in locally especially Sri Lankan context when considering women as main focal point. Therefore, this thesis would be adding more value to fill the literature gap.

### **1.1. Research Problem**

This research attempts to identify;

Does the (demographic factors) educational status, marital status, age, occupation, income composition, and other respective variables of Convenience, Security, Cost effective, perceived risk, Attitudes, and Knowledge and

accessibility significantly impact on the awareness and usage of e-banking services among women?

## **1.2. Research Objectives**

With this research, several objectives are aimed to be fulfilled. The main objectives of this research are as follows;

- To study the level of awareness and usage of e-banking services among women in Kundasale division
- To study the factors affecting the awareness and usage of e-banking services among women in Kundasale division.
- To study the barriers, affecting the usage and awareness of e-banking among women in Kundasale division.

## **2. Literature Review**

E-banking is a huge area which day by day develop and it also known as the internet banking, online banking, web banking, eBanking or e-banking. According to Singh and Grover (2011) mentioned taking evidence from Daniel (1999) define the e-banking as the delivery of banks information and service to customers via different delivery platforms that could be used with different terminal devices as personal computer or through mobile phones with browser or desktop software, telephone or digital television. According to Mia et al., (2007), the process e-banking is modeled as Client-Server Architecture. However, the e-banking is a product output of different generation of electronic transactions (Mia and Rahman, 2007). Furthermore, they revealed that ATMs, mobile banking or phone

banking, PC or house banking was the first stage at e-banking. Aithal et al., (2018) laid that banking industry has been taking advantages of the following technology products; Net Banking, Credit Card Online, One View, Insta Alerts, Mobile Banking, Net-Safe, e-Monies Electronic Fund Transfer, Online Payment of Excise & Service Tax, Phone Banking, Shopping, Ticket Booking, further they said that Indian Banking Industry has greatly benefiting from the IT revolution all over the world and categorized virtual financial services as Automated Teller Machines, Remote Banking Services, Smart Cards, NRI Services. According to Jayasiri et al., (2016) cited on the evidence gathering from Jayamaha (2017) Sri Lanka was the first South Asian country to introduce unrestricted, commercial internet connectivity in April 1995. The concept of awareness attempt on explores how the customer knowing and knowledge of the products and services and to what extend they are lacking information about it (Mansor et. al, 2012)

### **2.1. Gender difference in awareness and usage of e- banking**

Gender is the key moderator in consumer behavior studies, and women and men are difference in their perception and evaluation of online platforms and systems. (Bendall-lyon and Powers, 2002; Dommeyer and Gross, 2003; Limet al., 2017 as cited Mahmoud, 2019). Alafeef and Ahmad (2011) examined on their research were done in Jordan, 88.31% of male were the users of internet rest of a lower percentage of (11.69%) were female who were the users of internet. And also, they revealed citing Vankatesh and Morris (2000) gender effects on innovation diffusion and the founded that gender is an important determinant of technology adoption and usage. Margret and Ngoma (2013) mentioned citing from Venkatesh and Morris (2000) gender has suggested as a factor which

influencing internet banking adoption while some researcher argue that the internet is male dominated. Mivechchi (2019) pointed out that present women have provided wide range of opportunities through information technology for the development of women therefore, women adopted in now in various types of business as their awareness in technology enhanced. A research done by Sailaja (2016) specially focusing on working women's awareness in online banking take demographic factors of age, marital status and income level conclude that main effect in course the unwillingness to take risk and attribute to safety.

### 3. Methodology

A visual presentation of the factors that have been identified for hypothesis development are shown below in Figure 3.1.

Figure 3.1: Conceptual Framework

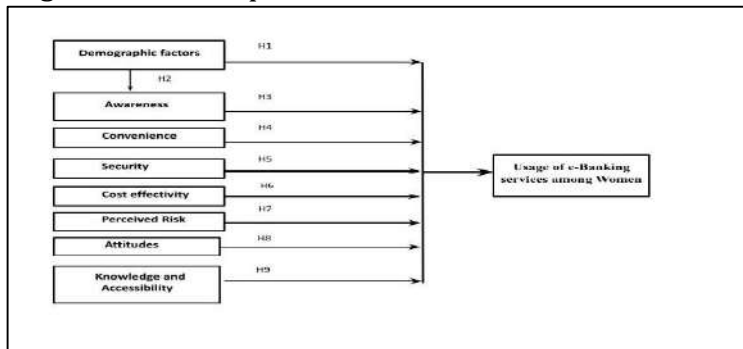

*Source: Author compiled*

According to Sekaran and Bougie (2010), hypothesis can be defined as a logically assumed relationship between



two or more variables expressed in the form of a testable statement. As identified in the theoretical framework, the researcher expects to establish a logically estimated relationship amongst the independent variables and dependent variable. Taking into account the previous research findings and the logical arguments presented in the literature review, the following research hypotheses can be proposed based on the theoretical model.

H<sub>1</sub>: Demographic factors has a significant impact on the Usage of e-banking services among women in Kundasale Division, Kandy.

H<sub>2</sub>: Demographic factors has a significant impact on the Awareness of e-banking services among women in Kundasale Division, Kandy.

H<sub>3</sub>: Awareness of e-banking services has a significant impact on the Usage of e-banking services among women in Kundasale Division, Kandy.

H<sub>4</sub>: Convenience has a significant impact on the usage of e-banking services among women in Kundasale Division, Kandy.

H<sub>5</sub>: Security has a significant impact on the usage of e-banking services among women in Kundasale Division, Kandy.

H<sub>6</sub>: Cost effective has a significant impact on the usage of e-banking services among women in Kundasale Division, Kandy.

H7: Perceived Risk has a significant impact on the usage of e-banking services among women in Kundasale Division, Kandy.

H8: Attitudes has a significant impact on the usage of e-banking services among women in Kundasale Division, Kandy.

H9: Knowledge and Accessibility has a significant impact on the usage of e-banking services among women in Kundasale Division, Kandy.

### **3.1. Defining of variables**

#### **3.1.1. E-Banking**

e- Banking defined as the delivery of banking service through electronic medias directly to customer's home or private places. According to Singh and Grover (2011) mentioned taking evidence from Daniel (1999) define the e-banking as the delivery of banks information and service to customers via different delivery platforms that could be used with different terminal devices as personal computer or through mobile phones with browser or desktop software, telephone or digital television.

#### **3.1.2. Awareness on e- banking**

Awareness of Internet Banking Hettiarachchi (2013) has identified 'awareness of internet banking' as a factor affecting the usage of e- Banking.

### **3.1.3. Demographic Factors**

Demographic factors which were used in variable testing; age, occupation, income level, marital status, educational level. Such factors were used to measure their effect on usage of internet banking in previous researches by Sharma (2011), Teka (2017), Singhal (2017), Jayasiri (2008) and Reshma et.,al (2017) and Batnagar and Rao (2014).

### **3.1.4. Convenience**

According to Dassanayake (2003), electronic banking is considered convenient in all aspects and is one of the main key factors influencing the use of online banking. They are open 24 hours a day, 7 days a week (Hettiarachchi, 2013). As a result, customers' banking needs will never have to wait until the next business day.

### **3.1.5. Speed and Reliability**

Deutsche Bank AG Research (2006) identified "speed" as one of the main drivers behind the success of Internet banking. Transactions, transaction processing, data transfer, information requests, etc. Transactions, transaction processing, data transfer, information requests etc. happen almost instantly in online banking

### **3.1.6. Security**

Georgia Institute of Technology Atlanta Report (2004) considers security of online banking to be a major factor affecting the usage. A common misconception associated with online banking is that it is vulnerable to security

threats.

### **3.1.7. Cost effective**

Mols (1998) has determined that online banking can be a low-cost alternative to traditional banking for customers. The term "cost" refers to all types of costs such as financial costs, time costs, energy costs, etc. All things considered, e-banking can provide banking activities at the lowest possible cost.. The term 'cost' refers to all types of costs from financial costs, time costs, energy costs etc. In all things considered, E-banking can provide a banking activity at the lowest cost possible.

### **3.1.8. Perceived Risk**

Customer perceives internet banking to be risky due to several reasons. Such as, an internet connection will be lost, lack of documentation proving a transaction, fear of losing PIN and cybercriminal accessing. (Arif et. al ,2020)

### **3.1.9. Attitude**

Davis (1989) and Karjaluoto et al. (2002) Define attitude as the willingness of users to use the system. E-banking users' attitude varied in terms of perceptions regarding service offered, risk involved, personalization, visual appeal, navigation, and enjoyment.(Ayo et. al, 2017)

### **3.1.10. Knowledge and Accessibility**

Accessibility of e-banking refer to the customer's easiness with the which customers have access to financial tools,

their accounts, ease of making payments from their accounts and access to money available in the accounts using various digital channels namely, online banking facilities, ATMs, POS terminals etc... (Muluka et., al,2015) Lack of computer literacy, high cost of hardware and call charges and various other social and economic factors are some of the reasons that negatively affected in accessibility. This is changing fast as more and more people connect to the Internet, and numbers are expected to grow even faster with the maturity of mobile communications (Kariyawasam and Jarasiri, 2016)

This study population focused on Women's where living in Kundasale Division in Kandy District. Kundasale division is a Semi- urban area which locate 6Km far away from Kandy town. This study was designed as a descriptive study by collect the questionnaire to analyze whether and how women awareness on e- banking services, in Kundasale Division. One of the most important requirements of data is that the collected data should be completed and accurate. This study had been organized to collect data from 380 samples of women living in Kundasale Division. A convenience sampling technique was used for sample selection. In this researcher has used primary data was collected through distributing questionnaires and it comprises with both Sinhala and English Languages according to respondents' convenience and knowledge with the goal of to obtain reliable answers for better analysis.

#### **4. Results and Discussion**

Out of 400 questioners which have distributed both printed and online form, the target sample was 380 respondents however 224 respondents were participated and researcher could have collect only 215 valid

respondents as other 185 have to rejects because of incomplete respondents. Hence, researcher considered and entered only those 215 fully completed responses into SPSS. Therefore, the response rate was 56%.

According to records of the Kundasale division there are more than 60,000 women, therefore according to Morgan table the selected sample size was 380 however the 185 were returned and incomplete. Therefore 214 questionnaires were processed for the analysis. In this study Age, Marital Status, educational level, income composition and occupation have been taken as the Demographic factors.

A higher number of respondents belonged to age 26-30 age group and respondents from 51-60 age group at least. Table 4.1 shows the percentage of respondents relevant to each age groups. The most of women respondents are married (61.7%) and rest 38.3% were unmarried. 50.9% of the sample were GCE A/L passed and 1.9% of respondents were graduate this demographic factor shows that the educational level is clearly affect on the awareness and usage of e-banking. Sample is comprised with the different level of income categories in between below 20 000 and above 100 000. 85 persons of the sample has middle range of income (Rs 21000 - 40000) while 42 persons including below Rs 20000 income group. Above figure express that the more than 39.7% of the sample has 21 000o above 40 000 income range. Many of women respondents were belongs to any of occupation category. Only 5.6% respondents were unemployed and 20.6% were self-employee and more respondent (21.0) were private sector employee

When considering the women respondents all the factors Mean Values were range between 4.0-4.30, Usage (US) shows the highest mean while Cost effective shows the lowest mean of 3.68. Standard deviation (SD) of variables

shows values less than 1 while Security and Cost effective is higher than one.

All were given their answers for the agreed level about the usage of e-banking. . SD is less than one representing that is, the variation in respondent's opinions was small among respondents. In brief Mean and SD was used to determine the extent of spread of the data.

Table 4.1: Descriptive Data

	N	Minimum	Maximum	Mean	Std. Deviation
	Statistic	Statistic	Statistic	Statistic	Statistic
Usage	214	2.60	5.00	4.3645	.52635
Awareness	214	2.00	5.00	3.9942	.79370
Convenience	214	2.50	5.00	4.2582	.64203
Security	214	2.00	5.00	3.8131	1.16878
Cost effective	214	2.00	5.00	3.6869	1.22383
Perceived Risk	214	2.00	5.00	4.2150	.74426
Attitude	214	2.67	5.00	4.2866	.68282
Knowledge	214	2.00	5.00	4.3049	.69173
Valid (listwise)	N 214				

Table 4.2 Multiple Regression Analysis

Model		Unstandardized Coefficients		Standardized Coefficients		t	Sig.
		B	Std. Error	Beta			
1	(Constant)	4.851	.231			20.998	.000
	Age	-.182	.032	-.499		-5.725	.000
	Marital Status	-.127	.075	-.117		-1.678	.095
	Educational Qualification	.012	.039	.024		.306	.760
	Monthly Income Level	.130	.043	.215		3.001	.003
	Occupation	-.040	.020	-.144		-2.019	.045

a. Dependent Variable: Usage

*Source: Author compiled*



$$US = \alpha + \beta_1AG + \beta_2MS + \beta_3IEDU + \beta_4MI + \beta_5OC \quad - \text{Equation 01}$$

$$US = 4.851 - .182AG - .127MS + .012EDU + .130MI - .040OC \quad - \text{Equation 02}$$

In above model it can be considered that the Age, Monthly Income level, and Occupation are significantly impact on the usage of e-banking among women. However, in the ANOVA table 4.8 shows that the overall model is significant to the p value of 0.000.

### **Impact on Demographic factors to the Awareness of e-banking services.**

According to measuring of demographic factors to the awareness of e banking the only demographic variable educational qualification insignificantly impacted to e-banking awareness among women in Kundasale division. Other all demographic variables; Age, Marital Status, Monthly income and occupation are significantly impacted to awareness of e-banking among women, out of this Age and Monthly income are highly significant (p=0.000).

Table 4.3 Multiple Regression Analysis

<b>Coefficients<sup>a</sup></b>					
Model	Unstandardized		Standardized	t	Sig.
	Coefficients		Coefficients		
	B	Std. Error	Beta		
(Constant)	5.092	.364		13.974	.000
Age	-.252	.050	-.460	-5.043	.000
Marital Status	-.376	.119	-.231	-3.159	.002
Educational Qualification	-.051	.061	-.070	-.841	.401
Monthly Income Level	.246	.068	.270	3.596	.000
Occupation	-.077	.031	-.182	-2.437	.016

a. Dependent Variable: Awareness

*Source: Author compiled*

$$AW = \alpha + \beta_1AG + \beta_2MS + \beta_3IEDU + \beta_4MI + \beta_5OC \quad \text{-Equation 03}$$

$$AW = 5.092 - .252G - .376MS - .051EDU + .246MI - .077OC \quad \text{-Equation 04}$$

According to the Regression analysis through the SPSS, researcher come across with the support of previous articles which Demographic factors of respondents are significantly impacted on the awareness and usage of e-banking which proof by the previous researcher such, Alafeef and Ahmad (2011) discovered on their research that demographic factors such as age, gender, income and educational level have strong effects on the mobile banking adoption in Jordan. Also, However , Izogo et., al. (2012) revealed that marital status, age and education level are important determinants of customers' adoption and usage of e-banking in Nigeria but this study found that the marital status has not significantly affect on the both awareness and usage of e-banking among women.

### **The impact of awareness on Usage of e-banking**

As per the results of below Table 4.1.1, Adjusted R square must be ( $0 \leq R^2 \leq 1$ ). Andalso Adjusted R square is the technique that can be used to measure overall significance of the model. In this case adjusted R<sup>2</sup> value is 0.652. It indicates a good level of prediction because 62.2% indicates that model is reasonable fitted to the data.

The R square value indicates how much of the total variation in the dependent variable can be explained by the

independent variables. According to the above result, 65% Awareness of e-banking services among women was described by the independent variables taken under this model and remaining 35% of organizational performance of State Banks is described by other factors which are beyond in the study.

Table 4.4 Multiple Regression Analysis

Coefficients <sup>a</sup>					
Model	Unstandardized		Standardized	t	Sig.
	Coefficients		Coefficients		
	B	Std. Error	Beta		
(Constant)	2.223	.109		20.371	.000
Awareness	.536	.027	.809	20.014	.000

a. Dependent Variable: Usage

*Source: Author Compiled*

Similarly, according to measuring of awareness to the usage of e banking services among women it shows that the awareness is significantly impact ( $p=0.000$ ) to the usage of e-banking services among women in Kundasale

division.

### Factors affecting usage of e-banking

Researcher considered the factors affecting to the e-banking services relating to previous articles such Convenience, Security, Cost effective, Perceived risk, Attitude, and Knowledge and accessibility to the internet, altogether six factors. According to the coefficient ( $p=0.000$ ) values it examine that the Security, Cost effective and Perceived risk were not significant to the usage of e-banking survives among women.

Table 4.5 Multiple regression analysis

Coefficients <sup>a</sup>					
Model	Unstandardized		Standardized	t	Sig.
	B	Std. Error	Beta		
(Constant)	1.967	.186		10.594	.000
Convenience	.416	.063	.507	6.552	.000
Security	.110	.056	.244	1.961	.051

Cost effective	-0.031	.057	-.072	-.544	.587
Perceived Risk	-.024	.061	-.034	-.394	.694
Attitude	-.241	.085	-.312	-2.837	.005
Knowledge	.338	.070	.445	4.818	.000

a. Dependent Variable: Usage

*Source: Author compiled*

According to Table 4.5 the multiple regression equation was,

$$US = \alpha + \beta_1CO + \beta_2SE + \beta_3CE + \beta_4PR + \beta_5AT + \beta_6KN \quad \text{-Equation 05}$$

$$US = 1.967 + .416CO + .110SE - .031CE - .024PR - .241AT + .338KN \quad \text{-Equation 06}$$

Finally it can be concluded that Convenience, Attitude, Knowledge and accessibility to the internet have a significant impact with usage of e-banking services among women in Kundasale division.

Therefore it supports to the previous finding that internet banking services offer, it would thus be expected that individuals who perceive internet banking as advantageous would also be likely to adopt the service (Tan & Teo, 2000). And it proof with previous articles according to Limsombunchai and Weng, (2006), there is significant impact to usage of e-banking from the perceived risk. Thus Attitude has impact on Usage of e-banking. According to (Ayo et. al, 2017)) Attitude has significantly impact on usage of e-banking. Thus this study also consists with previous studies, And it proof with previous articles according to (Kariyawasam and Jarasiri, 2016) there is significant impact to usage of e-banking from the Knowledge and accessibility.

### **Barriers affects to the usage and awareness of e-banking**

According to the survey done by researcher examine the barriers which affects to the usage and awareness of e-banking services among women, as per the selected factors, Convenience (CO), Security (SE), Cost Effective (CE), Perceived Risk (PR), Attitude (AT), Knowledge (KN) and Accessibility (ACC) to the internet considered to the study and according to examined by the researcher identified that above factors were may not highlt affected as

barriers to the e-banking usage among women in Kundasale division as their more respondents belongs to Agree and Strongly agreeable level.

Figure 4.1 Barriers affect to the usage and awareness of e-banking

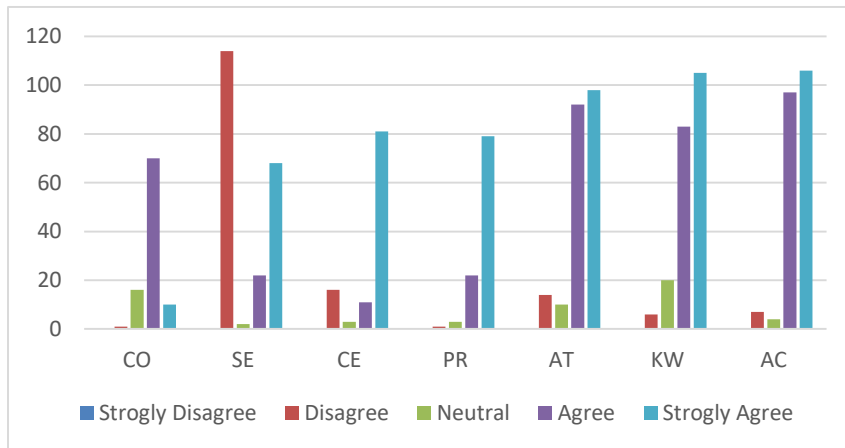

Source: Author Compiled

## 5. Conclusion and Recommendation

The main objectives of this study were to study the demographic factors and factors which affects on the awareness of e-banking services among women and barriers which pull away women to the not usage of e-banking services. For this analysis demographic factors such Age, Marital status , Educational level ,Occupation and Income level were taken as independents variable and for the factor analysis convenience, security, perceived



risk, cost effective ,attitude and Knowledge and accessibility were taken as variables and measure significant impact of awareness to the usage of e-banking services among women. Nine hypotheses were built by the researcher accordingly. The researcher conducts a pilot test. All the other variables recorded Cronbach's Alpha above 0.5. The researcher used descriptive and multiple regression analysis to investigate the relationship of independent variables to dependent variable. According to the results, all the other hypotheses were accepted as security, perceived risk and cost effective were rejected as there p value more than 0.05, also even the overall model for demographic factors to the awareness and usage were accepted the marital status showed the insignificant to the awareness and usage of e-banking services among women in Kundasale Division, Kandy. From the considered factors Convenience, attitude and Knowledge and accessibility to the internet were accepted.

Through the analysis done by survey the research have up with following conclusion,

- This study revealed that a major proportion of women customers were familiarized with internet and internet usage.
- According to Jayasiri (2016) identified that perception of risk of security in online banking has lost its significance over the years however according to survey researcher found that the women in Kundasale division have higher positive image on e-banking at the present and they raised with e-banking with cost effective, less risky and well secured product.
- Furthermore this research conclude that the women satisfaction level are in higher position with usage of

e-banking products and they less like to go physical bank branches.

- Additionally according to respondents in Kundasale Division, researcher found that the many of e-banking users have engaged with e-banking to pay utility bills, to recharge mobile phones and to check account balance.

The results of the analysis support and reinforce the effect between factors which consider by researcher with respective to previous researches such Sailaja (2015), Bhatnagar and Rao (2014), Teka and Sharma, (2017), Alafeef et al., (2011), Abayomi et al., (2019), Kariyawasam and Jayasiri (2016), Tiffany and Sangeetha (2018), Reshma et al., (2017), Littler and Melanthion (2006), Kotler and Keller (2006) above all researcher are supportive to current research hypothesis. Therefore, it can be concluded there are other than marital status to the awareness and usage, the all other demographic factors and variables (convenience, attitude and knowledge and accessibility to the internet) are significantly impact in the usage of e-banking services among women in Kundasale division, Kandy.

This study examined the factors (both demographic and other) which affects in the usage of e-banking services among women. As mentioned in the literature review and introduction chapters the Sri Lankan women are comparability less aware and contribute their less usage to the e-banking services. And their enthusiasm to the participate to the survey become less when examine the age level, especially elder level groups, And some are think as this is shame to reveal their opinions openly, therefore it should be encourage Sri Lankan women to new technology and should take actions to come out with the framed culture and living life to enhanced them with

financially. The findings of this study provide support for the current literature on e-banking services. The results support the view that the intention to use e-banking services is influenced by several major factors, including, perceived risk, security, cost effective, Attitude, Knowledge and accessibility. However, these factors are notable as barriers to intention to use e-banking services among women.

The researcher was found some limitations when conducting the research as presented through the limitations of the study section in the first chapter. Therefore, the researcher proposed some recommendations for future researchers who interested in this area, for the purpose of making some improvements as follows. First, the survey to collect data for this research was only conducted in the Kundasale division in Kandy district, Central province. Therefore the results of the study may not reflex truly for the whole Sri Lankan women. Therefore, the further researches who related to this area are suggested to include more coverage areas or suggested to conduct a survey for the whole, will increase reliability. Second, the number of participants in the survey was quite small. Further research should increase the number of participants and put more time in doing research that could improve the quality of the research.

In addition, This research investigated the impact of demographic factors and other related factors on awareness and usage of e-banking services, by taking demographic factors, convenience, security, perceived risk, cost effective, attitude and knowledge and accessibility as of dependent variables, that might insufficient to provide further evidences and explanations regarding this area. Therefore, strongly recommended that, the future researchers have to add more dimensions dependent variables in their research which will increase the

significant of the research. And also the very important point that researcher found here was the respondents rate of elderly women was very few. Therefore upcoming researches could take such lacking areas like seniors citizen awareness to the e-banking under their examine as there respondent rate was less when comparing to other age group response rate.

## 6. References

Abayomi, O. J., Olabode, A. C., Reyad, M. A. H., Tetteh Teye, E., Haq, M. N., & Mensah, E. T. (2019). Effects of Demographic Factors on Customers' Mobile Banking Services Adoption in Nigeria. *International Journal of Business and Social Science*, 10(1). <https://doi.org/10.30845/ijbss.v10n1p9>

Aithal, S., Kumar, A., M, M.(2018). Investigation of Business Strategies in Higher Education Service Model of Selected Private Universities in India. *International Journal of Computational Research and Development (IJCRD)*, 3(1), 77–100. <https://doi.org/10.5281/zenodo.1209910>

Alafeef, M., Singh, D., & Ahmad, K. (2011). Influence of demographic factors on the adoption level of mobile banking applications in Jordan. *Journal of Convergence Information Technology*, 6(12), 107–113. <https://doi.org/10.4156/jcit.vol6.issue12.14>

Daniel, E. (1999). Provision of electronic banking in the UK and the Republic of Ireland. *International Journal of Bank Marketing*, 17(2), 72–83. <https://doi.org/10.1108/02652329910258934>

Elizabeth, D. (2000). The provision of electronic banking services in the UK and Scandinavia. *Journal of Financial Services Marketing*, 4(4), 319–330. [http://oro.open.ac.uk/15954/2/SCANPAP\\_final\\_revised.pdf](http://oro.open.ac.uk/15954/2/SCANPAP_final_revised.pdf)

Jayasiri, N. K., Kariyawasam Graduate, N. J., & Jayasiri, N. K. (2016). Awareness and Usage of Internet Banking

Facilities in Sri Lanka. *International Journal of Scientific Research and Innovative Technology*, 3(6), 2313–3759. <https://www.researchgate.net/publication/318929992>

Mansor, N., Shariff, A. M., Manap, N. R. A. (2012). Determinants of awareness on Islamic financial institution e-banking among Malaysian SMEs. *International Journal of Business and Social Science*, 3(5), 93–101.

Mia, M., Rahman, M., & Debnath, N. (2007). Consumer Behavior of Online Banking in Bangladesh. *Journal of Business Studies*, 28(2).

Nagaraj, R., & Jegatheeswari, D. P. (2016). A Study on the Customer Awareness of E-Banking Services in Madurai City. *Ijsdr*, 1(8), 219–234.

S, R., S, A. D., & . Binu K J. (2017). Awareness of E-Banking Services among Rural Customers. *International Journal of Innovative Science and Research Technology*, 2(4). [www.ijisrt.com](http://www.ijisrt.com)

Sailaja, M., & Professor, A. (2015). Awareness and Use of Online Banking by Working Women.

Teka, B. M., & Sharma, D. (2017). Influence of Demographic Factors on Users' Adoption of Electronic Banking in Ethiopia. *Journal of Internet Banking and Commerce*, 22(S7), 1–17. [https://search.proquest.com/docview/1881412962?accountid=14744%0Ahttps://cbuaus.primo.exlibrisgroup.com/discovery/openurl?institution=34CBUA\\_US&vid=34CBUA\\_US:VU1&lang=es?url\\_ver=Z39.88-2004&rft\\_val\\_fmt=info:ofi/fmt:kev:mtx:journal&genre=article&sid=ProQ:](https://search.proquest.com/docview/1881412962?accountid=14744%0Ahttps://cbuaus.primo.exlibrisgroup.com/discovery/openurl?institution=34CBUA_US&vid=34CBUA_US:VU1&lang=es?url_ver=Z39.88-2004&rft_val_fmt=info:ofi/fmt:kev:mtx:journal&genre=article&sid=ProQ:)

Viswanath Vankatesh, & G., M. M. (2000). Why Don't Men Ever Stop to Ask for Directions? Gender, Social Influence, and Their Role in Technology Acceptance and Usage Behavior. 1(24), 115–139.

**IMPACT OF COVID – 19 PANDEMIC ON DEBT SECURITIES IN SRI LANKA**Krishanth, P. <sup>1</sup> and Buddika, H.J.R.<sup>2</sup>**Abstract**

**Introduction-** This study is conducted on the debt securities of Sri Lanka during the COVID – 19 pandemic. This study explores the impact of the COVID – 19 pandemic outbreak and the relevant factors on the debt securities yield in Sri Lanka.

**Design/Methodology/Approach-** The study consists of COVID-19 confirmed cases, inflation rate, interest rate, economic growth rate and foreign investment and the data was collected for the period of January 27th, 2020, to August 31st, 2021. This study uses the time-series regression model to evaluate the impact of the daily increase in the COVID confirmed cases during the pandemic on the debt securities yield.

**Findings-** According to the results, the interest rate and foreign investment exhibited a significant positive relationship with the debt securities yield. The variables inflation rate and economic growth rate displayed a significant negative relationship with the debt securities yield. Moreover, the COVID-19 confirmed cases had an insignificant positive moderation impact on the debt securities.

**Conclusion –** The outcome of the study emphasizes that the overall model is statistically significant, and the study concludes that there is a positive relationship between the COVID-19 confirmed cases and the debt securities in Sri Lanka.

**Keywords:** *Pandemic, Confirmed cases, Debt securities yield, Stock market, Sri Lanka.*

**Cite this paper as:**

Krishanth, P. and Buddika, H.J.R. IMPACT OF COVID – 19 PANDEMIC ON DEBT SECURITIES IN SRI LANKA *10<sup>th</sup> Students' Research Symposium, Department of Finance, University of Kelaniya, Sri Lanka.* 4. 81-108

<sup>1,2</sup>Department of Finance, Faculty of Commerce and Management Studies, University of Kelaniya

## 1. Introduction

COVID – 19 is part of a broad group of (SARS) viruses. The Chinese authorities identified this novel Coronavirus stain in Wuhan City, Hubei province of China. On 30th January, World Health Organization declared COVID – 19 outbreak a global emergency (WHO, 2020). The impact is still counting on exponentially, with the death rates and the infected cases. According to WHO 2021, The confirmed cases were almost close to 200 million, and the deaths recorded were more than 4 million across the globe by June.

The IMF lowered its growth projection about the global economy as the COVID-19 outbreak turned its earlier projection upside-down (Ozili, 2020). As a result, the global growth projection for 2020 was -4.9% (IMF, 2020). According to Ozili (2020), uncertainty caused by the adverse impact of COVID – 19 has made the global stock markets lose about 6 trillion US Dollars in just one week from 24th to 28th February, and the S&P 500 index lost over 5 trillion US Dollars in value in the same week. The global pandemic severely disturbed industries such as tourism, aviation, manufacturing, and food services.

Sri Lanka is a thriving developing economy predominantly based on Agriculture, Services, and Trade. Moreover, it has also suffered the adverse impacts of the global pandemic. As a result, the economic growth of Sri Lanka dropped to a lower level. "Amid the COVID-19 pandemic, Sri Lanka's economy contracted by 3.6 per cent in 2020, the worst growth performance on record" (World Bank, 2021). According to the Central Bank of Sri Lanka 2020, the country observed almost a 70% outward discharge of foreign-owned T-bills and T-bonds (US\$ 372 million) within two months period.

**1.1. Research Gaps**

In the Sri Lankan context, we often analyze the stock market indices and their performances. Nevertheless, the debt securities market has not been deeply examined. Sri Lanka's debt securities market was small, volatile, and underperforming till the 2000s. After that, it had an exponential growth till 2010 (trillion rupees value). Eventually, the Debt securities market started gradually declining after 2010. (Central Bank of Sri Lanka, 2015). Sri Lanka is more of a pre-emerging market in the world in recent times. Due to COVID- 19, the debt securities also got badly affected. "Government Securities Market a downward adjustment in government securities yield rates were generally observed throughout 2020" (Central Bank of Sri Lanka, 2020). Lennart & Malin (2000) researched the Sri Lankan debt market, which is outdated for the current situation.

**1.2. Research Objectives**

There is a requirement to recover from the repercussions and strengthen the debt market of Sri Lanka. We have to analyze and understand the impact to respond to the challenge. Studies have helped policymakers to prepare more viable and effective strategies. This study explores the impact of the Covid-19 pandemic on the debt securities in Sri Lanka. The crucial factors affecting the debt securities yields are Inflation rate, Foreign Investment, Interest rate, and Economic Growth. The utmost goal of this research is to test the relationship existing between the effect of the Covid-19 daily infection rate and the debt securities yield. Moreover, this study will examine the moderating influence of the pandemic on the above-mentioned significant factors that affect the debt security yields.



### **1.3. Research Questions**

This study answers the following research questions,

1. Does the daily confirmed cases in Sri Lanka has a moderate impact on the debt securities yield?
2. Do the other independent variables such as inflation, interest rate, economic growth rate, and foreign investment impact the Debt securities yield?

### **1.4. Research Limitation**

The major limitation of the study is the determining variables. It is impossible to specify all the actual variables affecting the debt securities yield. Adding qualitative variables might increase the accuracy and reliability of the results. The other limitation of this research is that it did not consider the influence of the Sri Lankan government's monetary and fiscal policy measures during the pandemic. If these were included, it might explain the movements of the debt securities yield more in detail. Here, Short -term debt securities yields are used because the pandemic considerably has a significant impact in the short term. Taking the long-term bond would not be more appropriate because the pandemic effect will be neutralized in the long run. “The negative market reactions to the COVID-19 pandemic have dissipated quickly during the 60 days after the event date”, (Harjoto & Rossi, 2020). Moreover, various factors could have been included in the study, such as Political Stability, External Agreements, Credit ratings and Crime rates which may provide more interesting results in this context.

**1.5. Significance of the Study**

Several papers have investigated the impact of COVID-19 and its consequences on stock markets (e.g., Amin et al., 2021; Anh & Gan, 2020; Wu & Hui, 2021). These studies, nevertheless, focus on developed and emerging stock markets, specifically equity stocks. There is a lack of studies exploring the effects of COVID-19 on Foreign Investment, Interest rate, Inflation rate, and economic growth, which affect the debt securities yield as a whole in Sri Lanka. This is the first study to explore the repercussions of COVID-19 on debt securities yields in Sri Lanka. The particular effects of the Foreign Investment, Interest rate, Inflation rate, and Economic growth during the pandemic on the Sri Lankan debt securities responses are covered in this study. As a key contribution, this study is a pioneer endeavour to assess the extent to which the Sri Lankan debt securities have been impacted by the novel COVID-19 pandemic.

**2. Literature Review**

Pandemic is not a new term to the world countries. Unlike other happenings, pandemics create a long-term impact around the globe. Nevertheless, COVID – 19 spread is indeed a tragic circumstance for us. The Black Death "Plague Outbreak", the Bleeding Fever, the Cholera epidemic, the AIDS virus in Cameroon, severe acute respiratory syndrome (SARS), Ebola and Swine Flu are some of them (Zeren & Hizarci, 2020). Stock market performances respond to significant events such as Disasters, wars, Crises and Pandemics (Al-Awadhi et al., 2020). The pandemic has fostered devastation to the global economy and the financial markets.

Coronavirus originated from the epicentre Wuhan city, China. The COVID – 19 pandemic has pessimistically hit

the international trade, tourism and hospitality, aviation and transportation industries (Wu & Hui, 2021). According to scholar findings, it was found that the systemic financial risk of each country magnified significantly during the pandemic. An essential pillar of the economy, stock markets could not avoid the consequences and showed a bearish trend globally.

Ever since the outburst of the novel Coronavirus, to effectively contain the spread of the virus, many countries have implemented a set of necessary guidelines, including the closure of productions, Work from Home opportunities, and home quarantine regulations. The enactment of these strict measures has brought up a more significant influence on the economic flourishing and the operation of businesses. Most developing countries are highly dependent on foreign investments, foreign debts and imports, which encourages those countries to worsen the health of the whole economy. As discussed in the "Impact of Covid-19 on the Global Economy WFR May\_June, Siddique K." (2020), The pandemic has unfolded the pitfalls of capitalist globalization. It has reinstated the understanding of the significance of sovereignty, national economy, and domestic markets.

Recently, only a limited number of studies have examined the impact of the global pandemic on the financial markets. To be more specific, studies rarely look into debt securities. Researchers analyzed the repercussions of the COVID – 19 pandemic in many different ways. According to Wang et al., (2020), the impact on GDP was based on the daily measure of passengers in trains during the pandemic. There was a strong strike on the volatility of the Shenzhen and Shanghai stock exchanges (Corbet et al., 2020). Jiang et al., (2017) evaluated the relationship between the (H7N9) bird flu virus and the Chinese stock market. They found that the daily number of infected

cases increased dramatically and negatively affected the stock prices on the overall market index and relevant sectors. (Baig et al., 2020) scrutinized the influence of COVID-19 on the liquidity of the stock market and the turbulence on the stock market performance. Subsequently, the increase in the number of confirmed cases and deaths guaranteed due to COVID-19 had significantly increased financial markets instability and strict closure measures, undermining the market potential and resilience.

Documented studies show that there is a correlation between pandemic confirmed cases and the securities. Al-Awadhi et al., (2020) show that both the daily increase in the number of confirmed cases and deaths of COVID-19 the return of shares affected pessimistically in all firms in China. Ashraf (2020) investigated the influence of the stock market operating in 64 countries and is experiencing an inverse relationship between growing numbers of infected cases and returns of the stocks. Zhang et al., (2020) confirm the adverse effects of COVID-19 on the stock markets of the ten most dominant markets, such as Japan, Korea, and Singapore.

Sri Lanka is also among the countries badly affected by the pandemic, which is still struggling through its tragic journey. It collapsed the whole economy, including the financial markets. The trade balance, unemployment, inflation, interest rates and foreign investment and credit ratings displayed unpleasant outcomes during the pandemic. As a result, IMF downgraded Sri Lanka to the lower-middle-class income group (IMF, 2021). The GDP per capita decreased from 3,853 USD to 3,679 USD (WHO, 2020).

The Sri Lankan stock market is a pre-emerging frontier market. Bond Market in Sri Lanka initiated active operations in 1990. Government securities are of two types, the rupee-securities and foreign currency securities.

Rupee-denominated securities involve Treasury bills and Treasury Bonds. Foreign currency-denominated securities comprise only Treasury bonds such as Sri Lanka Development Bonds (SLDB) and Sri Lanka International Royal Bonds (Central Bank of Sri Lanka). Sri Lanka's total domestic debt is made up of short-term T-Bills, the Advances of the Central Bank, Medium-term & Long-term Treasury Bonds, Rupee Loans and SLDBs. Sri Lanka relies heavily on short-term financing to meet government spending needs.

CBSL had to lower the Interest rates due to massive panic caused by the pandemic (Central Bank of Sri Lanka, 2020). Studies have shown that there is always a strong positive relationship between interest rates and bond yields (How Are Bond Yields Affected by Monetary Policy?, n.d.). The Inflation went on to rise even more in Sri Lanka during the pandemic. Bonds yields tend to rise with the inflation rate because it will crumble down the purchasing power of the bond cash flows. Adding to that, investors demand a higher yield rate to compensate for the inflation risk in the economy (Understanding Interest Rates, Inflation, and Bonds, n.d.). Economic growth is positively correlated with bond yields. Because the underlying cause of increased inflation and interest rates while the economy grows, induces pressure on bond yields (What Economic Factors Influence Corporate Bond Yields?, n.d.). Foreign Investment has a significant influence on bond yields. "Foreign ownership tends to lower the yield and yields volatility in the country having strong macro-economic fundamentals" (Muharam et al., 2018). According to the KPMG Report (2020), foreign holdings in treasury bills and bonds reduced by almost 60% to LKR 41.6 billion in March and yield rates were rising.

According to Wang et al., (2020), the event study method was used to examine the repercussions of pandemic

outbreaks on Taiwan's biotechnology industry which produced abnormal returns. Al-Awadhi et al., (2020) used the panel data regression testing analysis and found that the pandemic has negatively impacted the Chinese stock market returns. Comparably, He et al. (2020) found that the information technology, Healthcare, Education and Manufacturing industries were adaptable to the pandemic using the panel data regression methodology on the daily stock market indices of the Chinese stock markets. A study conducted on the American wine demand and supply during the pandemic has used time-series data. “Characteristic to TS analysis, no a priori assumptions about the causal relationship is made and the data is allowed to speak” (Huq et al., 2021). Based on this existing literature, assume that the time-series data regression model will be more appropriate to investigate the debt securities yield rate fluctuations during the pandemic time frame in Sri Lanka.

While considering the time durations of the existing works of literature are very limited to short periods. “The study used the empirical data of three regions: South America, North America and Central America, for the period March 10 to April 9, 2020,” (Amin et al., 2020). According to the study by Trang and Gan (2020), The daily stock data start on 30 January 2020, and the end date of the daily stock data is 30 May 2020. “Therefore, the overall returns data that are used in our study span from December 27, 2018, through June 3, 2020”, (Harjota and Rossi, 2020). This study further extends the time duration for the assumed model. This research will be taking data for 582 days.

Time-series data regression inputs the daily data within a given time frame to analyze the trends of the variables. This will be the initial research to use this model to examine the impact of the COVID – 19 pandemic on the Sri

Lankan bond market. Since no studies have examined the debt securities market using the time-series data regression in Sri Lanka. This study will support domestic investors and foreign investors to mindfully invest in the bond market of Sri Lanka during a crisis.

However, limited studies assess the influence of pandemics on Sri Lankan bond markets and their security yields. Sri Lanka is a rapidly developing economy that successfully controlled the pandemic and revived the financial markets in 2020. COVID -19 has indirectly impacted the debt market. This study competently attempts to inspect the extent to which the Sri Lankan debt securities market has been affected by the COVID-19 pandemic. Since Sri Lanka is a developing economy, the outcomes of this study can be a basis for guidelines for analyzing the impact of the pandemic on the debt securities market in other developing economies as well. These gaps in the literature and the potential development of the Sri Lankan bond market encouraged me to conduct this research.

### **3. Methodology**

#### **3.1. Data**

This study evaluates the effects of the COVID-19 epidemic and the significant factors such as inflation, interest rate, economic growth, and foreign investment on the yield of the debt securities in the Sri Lankan bond market. This study aimed to determine the debt securities yield reaction to the COVID-19 epidemic in the Sri Lankan bond market. For this purpose, we use the number of Covid positive cases daily (from the first reported case in Sri Lanka) to determine the severity of the deadly disease. The bond yields' response was assessed using the daily

debt securities yield rate changes in the market. In addition, the study used time-series data ranging from January 27th 2020 to August 31st 2021, which was categorized as the 1st wave, 2nd wave, and 3rd wave intervals to review the bond yield pattern. It sums up to a count of 582 days of duration. The 1st wave was from 27/01/2020 to 03/10/2020, 2nd wave was from 04/10/2020 to 14/04/2021 and the 3rd wave was from 14/04/2021 to 31/08/2021.

Daily bond yield data starts from the 27th of January 2020, which was the first working day since the first infected corona case of COVID-19 was declared in Sri Lanka. The daily date for bond yield data ends on 31st August 2021. The daily number of infected cases in Sri Lanka was collected from the website of the Department of Health, Sri Lanka (<https://hpb.health.gov.lk/covid19-dashboard/>). The input data was collected from the sources such as Central Bank reports, IMF reports, WHO Statistics, Colombo Stock Exchange Publications, Sri Lanka Health Ministry website. The data was collected on the website that provides real-time COVID – 19 confirmed cases statistics of Sri Lanka. In addition, bond yields data were fetched at [investing.com](https://www.investing.com/rates-bonds/sri-lanka/) (<https://www.investing.com/rates-bonds/sri-lanka/>).

Al-Awadhi et al. (2020) and Ashraf (2020), while assessing the impact of the COVID-19 pandemic on the returns of stock markets, explain that the intensity of the pandemic was not on the very first day of the pandemic. By Al-Awadhi et al. (2020), Trang & Gan (2020), Amin et al. (2020), and Ashraf (2020), this study uses the time-series regression analysis approach, which is much more appropriate for this field than the classical event study methods used in the other analysis.



While assessing the impact of COVID-19 during the pandemic period on Sri Lankan debt securities market performance, this study adopts a time-series regression model which is quite similar to the regression model of Hensler et al. (2021) to evaluate the effect of daily increases on the number of COVID-19 cases in the dependent variable of this study. Variables of the model are the demand and supply for the American wines in the study conducted in the USA by Hensler, Jones and Huq in 2021. Nevertheless, the independent variables such as Interest rate, Inflation, Economic growth, and Foreign Investment which affects the dependent variable, T-bill Yields are included in this study.

The regression model:

The model examines the impact of the COVID – 19 pandemic on the debt securities yields:

$$BY_t = \alpha_1 + \alpha_2 \text{CASE} + \alpha_3 \text{INTER} + \alpha_4 \text{INFL} + \alpha_5 \text{GDP} + \alpha_6 \text{FINV} + \varepsilon_{0t}$$

$BY_{t}$  is the yield of the T.Bill on day t.

CASE is the total number of positive COVID -19 cases in Sri Lanka on day t.

INTER is the interest rate in Sri Lanka on day t.

INFL is the inflation rate in Sri Lanka on day t.

GDP is the economic growth rate in Sri Lanka.

FINV is the foreign investment in bonds in Sri Lanka.

This study formulates the following hypothesis to test,

H<sub>1</sub>: There is a significant positive relationship between foreign investments and debt securities yield.

H<sub>2</sub>: There is a significant positive relationship between inflation and debt securities yield.

H<sub>3</sub>: There is a significant positive relationship between interest rate and debt securities yield.

H<sub>4</sub>: There is a significant positive relationship between economic growth and debt securities yield.

H<sub>5</sub>: There is a moderation impact from COVID -19 confirmed cases towards the debt securities yield.

The Breusch-Pagan test will be used to detect heteroscedasticity (Breusch & Pagan,1979). A Multi-collinearity test will also be conducted on the sample using the Variance Inflation Factor. The augmented Dickey-fuller test will be used to detect the unit root in the data (Fuss and Hermann, 2005).

Figure 3.1: Conceptual Framework

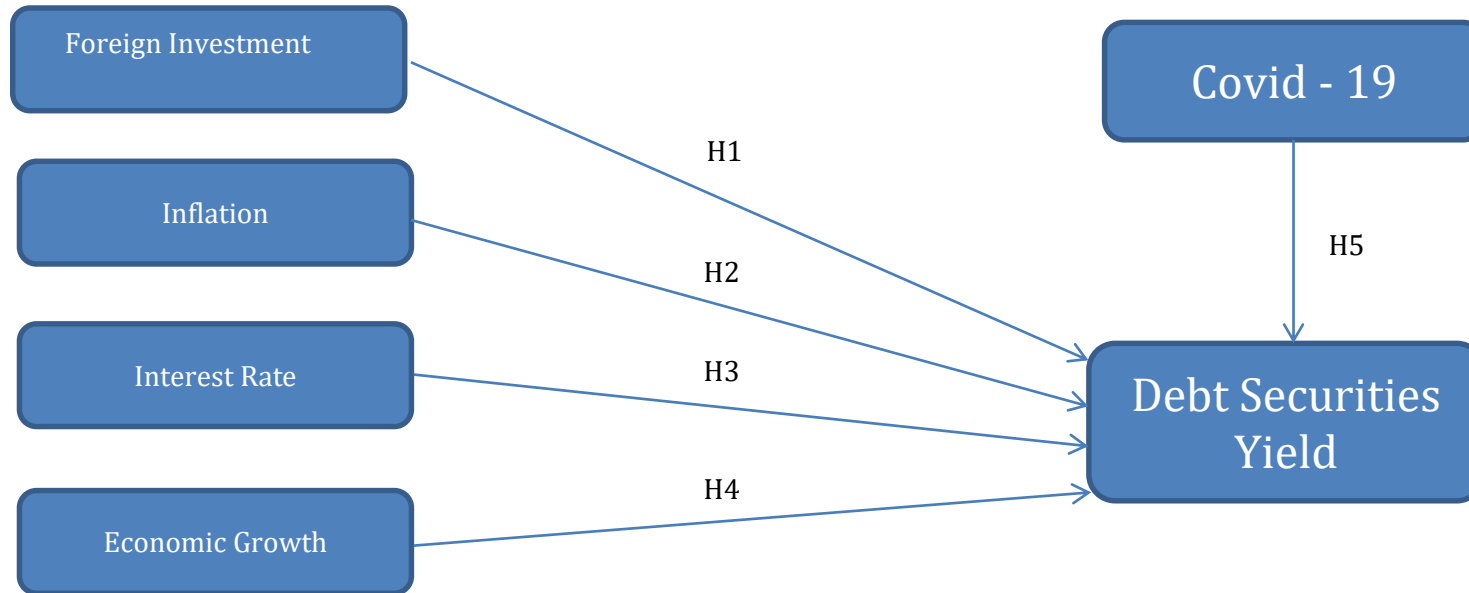

*Source: Author compiled*

## **4. Findings and Discussion**

### **4.1. Descriptive statistics**

Table 4.1.1. presents the descriptive statistics of all the variables in the model from the 27th of January 2020 to the 31st of August 2021. The number of observations was 584 in the study. The average debt securities yield in Sri Lanka is 5.54 per cent during the pandemic. The average number of COVID-19 confirmed cases was around 600 per day. The average inflation and interest rates were 5.8% and 5.1%, respectively. The average economic growth was around the 1.5 index mark and the average foreign investment was 114.3 million. The descriptive statistics and Pearson correlation are illustrated in Table 4.1.1 and Table 4.1.2, respectively.

### **4.2. Unit root test**

To check for the stationarity of the time-series data, as per (Fuss and Hermann, 2005) the Augmented Dickey-Fuller unit root test was applied. The test shows that the T- statistics of each variable were higher than the critical value. Which rejects the alternate hypothesis of the presence of unit root in the data. Unit root test confirms that all the variables were stationary at 5% and 10% levels of significance, which allows us to proceed with hypothesis testing.

### 4.3. Hypothesis Testing

The study used the Breusch-Pagan test for heteroscedasticity which showed the presence of heteroscedasticity. Popular techniques such as winsorization and trimming were used to eliminate the outliers in the data set. Finally, tried with natural log variable method. But still, it was able to notice the presence of heteroscedasticity.

The Multi-collinearity test confirmed that there is a weak correlation among the variables (Mansfield & Helms, 1982). Variance inflation factor values were around the mean of 2.06. Variance inflation factor values are shown in Table 4.1.3.

The first hypothesis was that there is a significant positive relationship between foreign investments and the debt securities yield. The results were positively significant at a 5% level of significance ( $p < 0.05$ ); hence, this hypothesis was supported.

The second hypothesis was that there is a significant positive relationship between the inflation rate and the debt securities yield. The results were negatively significant at a 5% level of significance, Contradicting the hypothesis, the results show a significant negative relationship between the inflation rate and the debt securities. therefore, our hypothesis was not supported by the results.

The third hypothesis was that there is a significant positive relationship between interest rate and debt securities. The results were positively significant at a 5% level of significance. hence, this hypothesis was supported by the output.

The fourth hypothesis was that there is a significant positive relationship between the economic growth rate and the debt securities. The result was negatively significant at the significance level of 5%, Contradicting the assumed hypothesis, the results show a significant negative relationship between economic growth rate and the debt securities yield. therefore, this hypothesis was not endorsed by the results.

The fifth hypothesis assumed that COVID-19 confirmed cases have a moderation impact on the debt securities yield. The result was positively significant at a 5% level of significance. This confirms the existence of the moderation impact of COVID -19 confirmed cases on the debt securities yield.

The R-squared value was 0.88. This shows that 88 per cent of the change in debt securities yield is predicted by the following variables inflation rate, interest rate, Economic growth, foreign investment, and the COVID-19 confirmed cases and the remaining 12 per cent is explained by other factors. The summary of regression outputs of the model is shown in Tables 4.1.4 and 4.1.5, respectively.

Table 4.1.4: Descriptive Statistics

VARIABLES	Mean	STD. DEVIATION
BY	5.546045	0.7954249

CASE	633.7625	741.3942
INFL	5.841781	1.011885
INTER	5.119298	0.8518971
GDP	1.592637	2.151516
FINV	114.3166	13.40388

---

*Source: Author Compiled*

Table 4.1.5 : Pearson's Correlation Matrix

BY	CASE	INFL	INTER	GDP	FINV	BY
CASE	1.0000					
INFL	0.1836	1.0000				
INTER	-0.2355	0.3569	1.0000			
GDP	0.0753	-0.6108	-0.4691	1.0000		

						<b>10<sup>th</sup> SRS - DFin</b>
FINV	0.2635	0.4547	0.3474	0.0223	1.0000	
BY	-0.1514	0.2440	0.9300	-0.3821	0.3539	1.0000

*Source: Author Compiled*

This study shows a variance inflation factor value of 2.06 which substantiates that an insignificant level of multicollinearity exists among the independent variables. Variance inflation factor values are shown in Table 4.1.3.

Table 4.1.3 : Variance Inflation Factor

Variables	VIF	1/VIF
INFL	2.58	0.387848
GDP	2.57	0.388762
FINV	2.04	0.490565
INTER	1.82	0.548286



CASE	1.28	0.783100
Mean VIF	2.06	

*Source: Author Compiled*

Table 4.1.4: Summary of Regression Output

Number of Observation	584		
F (5, 533)	837.07		
Prob > F	0.0000		
R-squared	0.8870		
Adjusted R-squared	0.8860		
Source	SS	Df	MS
Model	235.76804	5	47.1536048
Residual	30.249873	533	0.056332059
Total	265.793012	538	0.494039055

*Source: Author compiled*

Table 4.1.5 : Summary of Regression Output

BY	Coefficient	Std. Error	t	P > t	(95% Confidence Interval)	
FINV	0.0039392	0.0010497	3.75	0.000	0.0018771	0.0060013
INFL	-0.1491226	0.0189422	7.87	0.000	-0.1863332	-0.111912
INTER	0.9875939	0.0200729	49.20	0.000	0.9481623	1.027026
GDP	-0.0174392	0.0082334	2.12	0.035	-0.0336131	-0.0012653
CASE	0.0000885	0.0000156	5.67	0.000	0.0000579	0.0001191
_Cons	0.8961051	0.1226764	7.30	0.000	0.6551165	1.137094

*Source: Author compiled*

#### 4.4. Discussion

The outputs show that covid confirmed cases have very little effect on the debt securities yield. The First hypothesis was the positive association between foreign investment and debt securities yield and the third hypothesis was the positive association between interest rate and debt securities yield were supported by the results obtained from the analysis.

The reason for the contradicting result for the second hypothesis was inflation rate has a positive relationship with the debt securities price so when the debt security price goes up the security yields come down (Ngaruiya & Njuguna, 2016). Eventually, it confirms that inflation has a negative relationship with debt securities yield.

The reason for the rejection of the fourth hypothesis is that increased economic growth will indeed stimulate inflation to rise. Therefore, as accordingly mentioned in the previous paragraph, there is a negative relationship between the economic growth rate and debt securities yield.

Out of the five hypotheses only two were rejected and the rest of them were matching with the results. Among the independent variables, the interest rate showed a higher impact on the debt securities yield.

## **5. Conclusion**

This research explains the effect of COVID-19 confirmed cases and the other factors such as inflation, interest rate, economic growth, and foreign investment on the debt securities yield in Sri Lanka. Researchers have illustrated the adverse impact of natural disasters and pandemics on financial markets. This study contributes to the existing literature by analyzing the impact of the COVID-19 pandemic on the debt securities market. yield in Sri Lanka. More specifically, this research provides to the literature by testing the hypotheses with a time-series data set of the debt securities yield in Sri Lanka.

This study has answered the research questions.

1. It is confirmed that the daily COVID-19 confirmed cases in Sri Lanka have a moderation impact on the debt securities yield.
2. It is confirmed that the independent variables such as inflation, interest rate, economic growth, and foreign investment impacted the Debt securities yield.

Using the regression analysis, this study confirms that the daily increase in the number of confirmed COVID-19 cases has very limited positive association with the debt securities yield. According to Anh & Gan (2020), “the COVID-19 pandemic affected Vietnam’s stock markets adversely”. But, inconsistent with the study conducted in Vietnam our results have shown a positive interaction between the COVID-19 confirmed cases and the debt securities yield of Sri Lanka.

Furthermore, the bottlenecks associated with debt securities market operations should be addressed by the Sri Lankan financial market regulations to improve efficiency. Investors, therefore, should adopt various effective strategies and diversify their investment portfolios across both equity and debt securities to mitigate the significant impacts of a COVID-19 pandemic and future unexpected events on their investment. Sri Lankan government should focus on implementing appropriate measures and policies to protect the financial market from the expected future uncertainties to mitigate the impact.

### 5.1. Recommendations

Here, Short -term debt securities yields are used because the pandemic considerably has a significant impact in the short-term. The effect of such pandemics is always at the peak in the time of impact and gradually decline over time. But even though there is scope for future researchers, they can also measure and analyze the impact of pandemics on intermediate and long-term debt securities. Which will be a step for further addition in this field of study.

Moreover, Sri Lanka's debt market composition is highly dominated by government debt securities. The corporate debt securities have a residual market share of around 35%. Unlike, the government debt securities yield the private debt security yields are fixed for a certain period and they may differ across the companies and industries. So, it will be appropriate to study the corporate debt securities separately since it is a complex area. This can be considered to proceed that in the upcoming research by future practitioners. The industry average is also can be used in the study related to this subject matter.

## 6. References

- Amin, A., Arshad, M., Sultana, N., & Raof, R. (2021). Examination of impact of COVID 19 on stock market: evidence from American peninsula. *Journal of Economic and Administrative Sciences*, ahead-of(ahead-of-print). <https://doi.org/10.1108/jeas-07-2020-0127>
- Ngaruiya, M. & Njuguna, A. (2016). Influence of inflation on Bond Prices: A Survey of Bonds Listed at the Nairobi Securities. *American Journal of Economics* Vol.1. Issue No.2, pp 50-63, 2016.
- Anh, D. L. T., & Gan, C. (2020). The impact of the COVID-19 lockdown on stock market performance: evidence from Vietnam. *Journal of Economic Studies*, 48(4), 836–851. <https://doi.org/10.1108/jes-06-2020-0312>
- Annual Report 2020 | Central Bank of Sri Lanka. (2020). Central Bank of Sri Lanka. <https://www.cbsl.gov.lk/en/publications/economic-and-financial-reports/annual-reports/annual-report-2020>.
- Annual Report 2021 | Central Bank of Sri Lanka. (2021). Central Bank of Sri Lanka. <https://www.cbsl.gov.lk/en/publications/economic-and-financial-reports/annual-reports/annual-report-2021>.
- Ashraf, B. N. (2020). Stock markets' reaction to COVID-19: Cases or fatalities? *Research in International Business and Finance*, 54, 101249. <https://doi.org/10.1016/j.ribaf.2020.101249>
- Bae, G., & Kim, H. J. (2019). Relation between early e-WOM and average TV ratings. *Asia Pacific Journal of Marketing and Logistics*, 32(1), 135–148. <https://doi.org/10.1108/apjml-10-2018-0402>
- Bierens, H. J., & Guo, S. (1993). Testing stationarity and trend stationarity against the unit root hypothesis. *Econometric Reviews*, 12(1), 1–32. <https://doi.org/10.1080/07474939308800252>
- Breusch, T. S., & Pagan, A. R. (1979). A Simple Test for Heteroscedasticity and Random Coefficient Variation. *Econometrica*, 47(5), 1287. <https://doi.org/10.2307/1911963>

Buszko, M., Orzeszko, W., & Stawarz, M. (2021). COVID-19 pandemic and stability of stock market—A sectoral approach. *PLOS ONE*, 16(5), e0250938. <https://doi.org/10.1371/journal.pone.0250938>

Coronavirus (COVID-19) Sri Lanka - Analytics Dashboard. (2021). Ministry of Health, Sri Lanka. <https://hpb.health.gov.lk/covid19-dashboard/>

Corporate Finance Institute. (2022, January 14). Variance Inflation Factor (VIF). <https://corporatefinanceinstitute.com/resources/knowledge/other/variance-inflation-factor-vif/>

Harjoto, M. A., & Rossi, F. (2021). Market reaction to the COVID-19 pandemic:

evidence from emerging markets. *International Journal of Emerging Markets*, ahead-of(ahead-of-print). <https://doi.org/10.1108/ijoem-05-2020-0545>

Huq, F., Jones, V., & Hensler, D. A. (2021). A time series projection model of online seasonal demand for American wine and potential disruption in the supply channels due to COVID-19. *International Journal of Wine Business Research*, ahead-of(ahead-of-print). <https://doi.org/10.1108/ijwbr-03-2021-0015>

Insaidoo, M., Arthur, L., Amoako, S., & Andoh, F. K. (2021). Stock market performance and COVID-19 pandemic: evidence from a developing economy. *Journal of Chinese Economic and Foreign Trade Studies*, 14(1), 60–73. <https://doi.org/10.1108/jcefts-08-2020-0055>

Jarus, O. (2021, November 15). 20 of the worst epidemics and pandemics in history. *Livescience.Com*. <https://www.livescience.com/worst-epidemics-and-pandemics-in-history.html>

Jayakody, S. G. (2017). The impact of the Sri Lankan Civil War on the Stock market Performances. *International Journal of Economics and Financial Issues*, 2017, 7(1), 394-402.

Mansfield, E. R., & Helms, B. P. (1982). Detecting Multicollinearity. *The American Statistician*, 36(3a), 158–160. <https://doi.org/10.1080/00031305.1982.10482818>

Mezghani, T., Boujelbène, M., & Elbayar, M. (2021). Impact of COVID-19 pandemic on risk transmission between googling investor's sentiment, the Chinese stock and bond markets. *China Finance Review International*, 11(3), 322–348. <https://doi.org/10.1108/cfri-08-2020-0120>

Schoenfeld, J. (2020). The Invisible Risk: Pandemics and the Financial Markets. *SSRN Electronic Journal*. <https://doi.org/10.2139/ssrn.3567249>

Singhania, M., & Gupta, A. (2011). Determinants of foreign direct investment in India. *Journal of International Trade Law and Policy*, 10(1), 64–82. <https://doi.org/10.1108/14770021111116142>

Sri Lanka: WHO Coronavirus Disease (COVID-19) Dashboard With Vaccination Data. (2021). WHO Coronavirus (COVID-19) Dashboard with Vaccination Data. <https://covid19.who.int/region/searo/country/lk/>

Sumagaysay, L. (2020, November 27). The pandemic has more than doubled food-delivery apps' business. Now what? *MarketWatch*. <https://www.marketwatch.com/story/the-pandemic-has-more-than-doubled-americans-use-of-food-delivery-apps-but-that-doesnt-mean-the-companies-are-making-money-11606340169>

Thazhungal Govindan Nair, S. (2021). On extreme value theory in the presence of technical trend: pre and post Covid-19 analysis of cryptocurrency markets. *Journal of Financial Economic Policy*, ahead-of(ahead-of-print). <https://doi.org/10.1108/jfep-09-2021-0242>.

Vijaya Kittu, M., & Betsy Beatrice, B. (2019). Debt Market Crisis and its impact on Debt Mutual Funds. *Recent Trends in Indian, Financial System: Paradigms and Praxis*. Kottayam: Kristu Jyothi College of Management & Technology.

Wu, X., & Hui, X. (2021). The Impact of COVID-19 on the Dependence of Chinese Stock Market. *Discrete Dynamics in Nature and Society*, 2021, 1–11. <https://doi.org/10.1155/2021/5588562>



Zaghini, A. & European Central Bank. (2021). The Covid Pandemic in the Market: Infected, Immune and Cured Bonds. Universitätsbibliothek Johann Christian Senckenberg.

## EFFECT OF FINANCIAL PERFORMANCE ON SHARE PRICES DURING THE COVID-19 PANDEMIC: SPECIAL REFERENCE TO THE LISTED BANK, FINANCIAL, AND INSURANCE SECTOR IN SRI LANKA

Apasinghe N.V.N.N.<sup>1</sup> and Fernando. J.M.B.R<sup>2</sup>

### Abstract

**Introduction-** COVID-19 is a major health emergency recognized around the world. The investors invest in various types of investment avenues such as shares, treasury bonds, treasury bills, debentures and etc. Among these instruments, investment in company shares is an attractive way of profitable investment as far as the capital market is concerned. Most of the stakeholders are mainly concerned about the share price of the entity in the process of resource allocation. Hence this study examines the effect of financial performance on share prices during the COVID 19 pandemic.

**Design/Methodology/Approach-** The study used deductive approach. The study employed a survey questionnaire to collect the data and the sample consist with 113 respondents. Willingness to pay, accessibility, affordability, and consumer trust were used as the factors affecting introduction of micro-insurance schemes.

**Design/Methodology/Approach:** This study used panel data consisting of 20 listed banks, and financial and insurance sectors in Sri Lanka covering the period from 2018 to 2020 at the Colombo Stock Exchange. Return on assets, return on equity, return on investment, and earnings per share were used as financial performance measures and used two control variables; Board size and Firm Size. The study employed Ganger Causality test to find the effect of financial performances on the selected companies' share prices.

**Findings-** The study reveals that financial performance variables are Granger-cause average share price at its levels of significance during the COVID 19 pandemic consistent with the literature.

**Conclusion** – This study can assist the banking, finance, and insurance sector in Sri Lanka to get a better understanding of the financial performance of the share price during a pandemic. Stakeholders and bank managers will be able to use the results and findings from the results of this study and they can make more reliable and effective decisions during a pandemic.

**Keywords:** *Share Price, Financial performance, listed banks, financial and insurance sector, COVID pandemic*

#### Cite this paper as:

Apasinghe N.V.N.N. (2022). EFFECT OF FINANCIAL PERFORMANCE ON SHARE PRICES DURING THE COVID-19 PANDEMIC: SPECIAL REFERENCE TO THE LISTED BANK, FINANCIAL, AND INSURANCE SECTOR IN SRI LANKA *10<sup>th</sup> Students' Research Symposium, Department of Finance, University of Kelaniya, Sri Lanka*. 5. 109-132

<sup>1</sup>Department of Finance, Faculty of Commerce and Management Studies, University of Kelaniya ([niroshapinghe@gmail.com](mailto:niroshapinghe@gmail.com))

<sup>2</sup>Department of Finance, Faculty of Commerce and Management Studies, University of Kelaniya

## 1. Introduction

COVID-19 is a major health emergency recognized around the world. More than seven million people have been diagnosed worldwide, since January 2020, several countries and regions have been affected by the pandemic. Countries are forced to adopt quarantine measures because of the high infectiousness nature of COVID-19. These measures have a great negative impact on aggregate demand, especially on consumption and exports. The outbreak of the novel coronavirus (COVID-19) brought seriously affected health care, economy, transportation, and other fields in different industries and regions. Population mobility sharply dropped, as a result of the quarantine policy, which led to weakened spending power and a stagnant economy. At the macro level, the COVID-19 outbreak caused the worst global recession since 1930, when the economy got absolutely creamed. Over the centuries, there has been an increase in investment in various types of methods such as shares, treasury bonds, treasury bills, debentures and etc. Among these instruments, a share is an attractive way of profitable investment. Most of the stakeholders are mainly concerned about the share price of the entity in the process of resource allocation. The stock market that is a part of any economy plays a pivotal role in the economic growth and development of an economy which would benefit industries, trade, and commerce as a whole (Mehr-un-Nisa & Nishat, 2011). The investors analyze all factors that affect the share price before they are investing in the shares (Sultana & Pardhasaradhi, 2012). It is convenient to make better decisions regarding resource allocation based on the information disclosed in the financial statements (Glezakos, 2012).

However, a major problem with this kind of application is the fluctuation of the share price. The share price

fluctuates due to various economic and non-economic incidents such as elections, infectious, diseases, and natural disasters (Kalyanaraman & Tuwajri, 2014). Both qualitative factors such as a change in government policy, the international situation, and politics and quantitative factors such as earnings ratio, earning per share, net income, and return on the investment affect the share price (Sindhu , et al., 2014). Therefore, it is difficult to predict the share price of a particular company.

Many factors strongly influence the share price of the market (Mehr-un-Nisa & Nishat, 2011). Among those factors, financial performance is the measurable and available information to assess the share price ( Al-Qudah, et al., 2013). Therefore, the investors consider the financial performance of the company before making investment decisions (Naceur, 2003). Financial performance is a measurement of the financial health of the organization considered by the investors when they invest in the shares. Therefore, financial performance plays a significant role in measuring the overall growth of the company. The measurement of the performance in financial activities refers to the degree to which the financial objectives have been accomplished (Lambert & Larcker, 1987).

However, the analysts and investors desire to look deeper into the financial statements and seek out the margin growth rates, gross profit margin, return on investment, earnings per share, and any declining debt in considering the financial performance. Therefore, almost all the companies focus on improving financial performance as well as profitability and the way of surviving in the competitive market (Al-Matari, Al-Swidi, & Fadzil, 2014).

Though the investors need to observe important factors that affect the stock price, they cannot access all of the information available in the market (Glezakos, 2012). The financial performance disclosed in the financial

statements is a key factor in determining the share price (Sharma, 2011). The research on the impact of the financial performance on the share price has been mostly restricted by the comparisons of the factors that affect on the share price. Hence it is essential to identify the impact of the financial performance on the share price for investors before making the investment decisions.

The COVID-19 pandemic has disrupted every facet of life globally. Business and commerce are key areas where the monetary crunch has been acutely the various key changes in entities' activities to evaluate the level of business performance in response to the COVID-19 pandemic.

Previous studies have emerged contradictory findings on the relationship between financial performance and the share price. Hence, there is an inconclusive identification of how share price generally responds to financial performance. Kabajeh, Nuaimat, & Dahmash, (2012) have stated that there is a positive impact of the internal financial determinants such as return on equity, return on assets and return on investment on the share price. Sharif, Purohit, & Pillai, (2015) have conducted a study to analyze the determinants of the price of shares and the findings showed a positive significant relationship between ROE, BVS, DPS, price-earnings ratio, and the share price. He suggested that those factors act as active determinants in shaping the market price of shares.

Lack of studies in the Sri Lankan context has existed as a major problem for many years providing conclusive evidence on the relationship between financial performances and the share prices. Preston (1997) showed a significant negative and some studies found a positive influence of the financial performance on the share prices in the Sri Lankan context.

In some cases, the ratios of financial performance showed abnormal results with share prices and some studies have argued that there is no effect of the financial performance on the share price. Another most significant discussion is that financial performance negatively affects the share price. When increasing the financial performance, the share price indicates negative reactions (Menaje, 2012). Hence previous studies indicate much uncertainty about the relationship between financial performance and share price.

Most of the previous studies have reported all the possible factors affecting to the share price (Malhotra & Tandon, 2013). Those studies have not focused on the individual effect of financial performance on the share price. There has been little discussion on the relationship between financial performance and the share price. However, the researchers have tended to focus on determinants of share price rather than a relationship between financial performance and the share price.

Though there are studies carried out on the determinants of the share price in developed capital markets, inadequate studies exist for the relationship between the financial performance and the share price especially considering the Covid-19 impact. Therefore, this study set out to assess the effect of the financial performance on the share price and to focus on identifying the “impact of financial performance on the share price during the COVID-19 pandemic” relevant to the listed bank, financial and insurance sector in Sri Lanka.

Few researchers have been able to draw on the systematic research on the relationship between financial performance and the share price. When referring to the literature, it is found that there are no considerable studies in the Sri Lankan context. All other studies have been conducted in other economies. COVID-19 is a major

health emergency declared by the World Health Organization. More than seven million people have been diagnosed worldwide, since January 2020, 2, and several countries and regions are affected by the pandemic. Countries are forced to adopt quarantine measures because of the high infectiousness nature of COVID-19. These measures have a great negative impact on aggregate demand, especially on consumption and exports. On the one hand, people were asked to go out less, and crowded places such as shopping malls were shut down. On the other hand, several countries-imposed restrictions on imports to prevent viral transmission. There are several studies that have been conducted on Covid-19 and stock market performance. Sri Lanka context also there are studies on Covid-19 and some other aspects. But no studies have been done in Sri Lanka on the financial performance and share price during the Covid-19 period. Therefore, the studies are based on other economies, and due to the differences in their capital market, the conclusions of those studies cannot be generalized to the Sri Lankan context. However, there is a huge research gap in the Sri Lankan context and this study will be able to fill the research gap.

## **2. Literature Review**

When the company earns more profit, the investors would obtain high earnings per share as their income. In such a case, there is an increase in the financial performance and the demand for the shares. Then the share price increased. Therefore, the linear relationship between financial performance and share price has been established (Almumani, 2014). Some researchers have confirmed that financial performance is strongly related to the share price and showed a positive relationship between financial performance and the share price.

Obeidat, (2009) has found the evidences for the impact of the dividend per share, EPS, and book value per share on the stock market price in the Abu Dhabi securities market. He revealed that there is a positive trend in the relationship between earning per share, book value per share, and the share price. Arkan, (2016) took variables ROA, ROE, price-earnings ratio, and EPS to find out the relationship between the financial performance and the share price. The objective is whether corporate measurements are correlated with the share price or not. The researchers found when a company increased its performance on a consistent basis, the financial performance increases with the share price. Wang, Fu, and Luo, (2013) found out whether accounting information affects the stock price by using six accounting information indexes. There is a positive significant relationship between ROE, EPS, and the share price with special reference to the listed companies in Shanghai Stock Exchange in the year 2011.

Kabajeh, Nuaimat and Dahmash, (2012) showed the impact of ROI, ROE, and ROA ratios on the share price. There is a positive relationship between ROI, ROA, ROE together and the share price with special reference to insurance public companies share price in Jordan. ROI and ROA have a positive but low relationship with the share price and no relationship between the ROE and the share price in considering the impact of the ratios separately. Ansari (2013) conducted a study to examine the relationship between the profitability ratios: financial expenses ratio, return on equity, gross profit, margin ratio, return on assets ratio, and the share price. The conclusion showed a strong positive relationship between the profitability ratios and the share price except for the financial expenses ratio from 2005 to 2009, 66 listed companies on the Tehran stock exchange.



Almumani (2014) conducted a study to examine the fundamental factors that affect changes in long-term share price. The secondary data from the Amman stock exchange was used to identify the quantitative factors: price-earnings ratio, book value per share, and dividend pay-out that influence the share price for the listed banks over the period 2005-2011. The results of the study found that there are significant determinants of the share price and no long-term equilibrium relationship between the indicators of financial performance and the share price. Sharif, Purohit, and Pillai, (2015) conducted a study to analyze the determinants of the share price of the company listed on the Bahrain stock exchange. The financial data for the study was collected for the period 2006-2010 from the Bahrain stock exchange website and the findings showed a positive and significant relationship between ROE, BVS, DPS, price-earnings ratio, and the market price of shares, suggesting that these factors act as active determinants in shaping the market price of shares. Thus, according to the pecking order theory, the primary concern of a firm is to raise capital through retained earnings while the tradeoff between firm's bankruptcy cost and tax shield of debt is a secondary issue. Accordingly, profitable firms are likely to use retained earnings and make less use of debt relative to less profitable firms. It implies firm's performance and debt are expected to be negatively associated. The hypothesis is also supported by a number of studies, to them, the benefits of debt financing are less than its negative aspects, so firms will always prefer to fund investments from internal sources (Kester, 1986; Jensen & Meckling, 2002)

Ruf, Muralidhar, Brown, Janney & Paul, (2015) has attempted to study the quantitative factors that influence the share price in the banking sector in CSE for the period from 2005 to 2014. The findings showed that there was a positive correlation between earnings per share, book value per share, PE ratio, size, and the share price. Gill,

Biger, and Mathur (2012) conducted a study to find variables that explain the changes in the share price. The overall finding showed that price-earnings ratio, book value per share, dividend per share, and earnings per share significantly affected the share price of the companies in America. Buigut, Soi, Koskei, and Kibet (2013) studied the relationship between the capital structure and the share price in the energy sector during the period of 2006 to 2011. The researchers found that capital structure ratios: debt, equity, and gearing ratio positively affected the share price.

Mondal and Imran (2010) conducted research in the Dhaka context to examine the qualitative factors such as goodwill, change in government policy market sentiments, announcements, unexpected reasons, technical influence, print, and electronic media and international situations well as quantitative factors such as dividend, market capital, price-earnings ratio, EPS, net income, return on investment, retained earnings, merger, interest rates, stock split, margin loan, demand & supply of stock, inflation, exchange rates that affect the stock price. The qualitative and quantitative factors are influential to the market value of the firms. In 2009, 50 listed companies in OSIRIS electronic database were used to identify a positive relationship between EPS and the share price in the Philippines and the study recommends EPS as a predictor of the share price (Menaje & Placido, 2012).

However, some researchers had arguments about this positive relationship between financial performance and share price. The financial performance does not affect the share price. Though the general notion is when the financial performance increase, the share price would increase, there is a doubt about whether the financial performance affects the share price of the entity. Some studies concluded that there was a negative relationship

between financial performance and share price. Menaje and Placido (2012) revealed that the strong positive correlation of EPS with the share price and there is a significant negative impact of ROA on the financial performance in to share price.

Lack of the studies in Sri Lankan context has existed as a major problem for many years. Some researchers conducted the research that showed a significant negative and other studies show a positive influence of the financial performance on the share price and what the determinants of the share price are in the Sri Lankan context. Menike (2006) conducted a study to find that the macroeconomic variables affect the share price, and it is found that a negative relationship between the share price and inflation, and exchange rates. Geetha and Swaaminathan (2015) disclosed that the findings of the study can be misled because of the availability of extraneous variables in the automobile industry. The purpose of the paper is to analyze factors that determined the movements of the stock price upward or downward. The result is the same as the finding of Wijesinghe and Senarathne (2011). The results show that there is a significant positive impact of ASP on the ROA finance sector in Sri Lanka. Biyiri (2017) conducted a study in Sri Lankan context about the impact of internal factors on the share price with special reference to the hotel industry. Earnings per share, dividend per share, and return on equity have a strongly positive relationship with the stock price. Obeidat (2009) examines the internal financial determinants of Common Stock Market Price based on Abu Dhabi Securities Market. He measured the bank profitability by ROA and ROE. Results showed a positive relationship between performance and share price.

Some studies found that the COVID-19 outbreak has a significant negative impact on the performance of listed

Chinese companies by decreasing investment scales and reducing the total revenue. For the industries affected by the pandemic, such as tourism, catering, and transportation, there is a significant decline in corporate performance in the first quarter of 2020. The pandemic has a negative impact on the production, operation, and sales of these industries, which is eventually reflected in the negative return rate. Along the regional dimension, the negative impact is much more pronounced in high-affected areas as strict quarantine measures limit consumptions and productions, sending a negative signal to managers and its stakeholders. Financial constraints may make the operation even harder in the pandemic (COVID-19) (Shena, 2020).

### **3. Methodology**

#### **3.1. Population, Sample selection and Data Collection**

The population of the survey includes bank, financial and insurance company which are listed under the Colombo stock exchange in Sri Lanka. Samples Include 20 listed bank, financial and insurance sectors in Sri Lanka, which are listed under Colombo stock exchange covering the period of 2018 to 2020. According to Janlowicz (1987), generalization about the population from data collected using any sample is based on market capacity. In order to be able to generalize the research findings to the population, it is necessary to select samples of sufficient size. Large sample size is always better than a small one. Saunders, Lewis, and Thorn (1996) also point out that the larger the sample size, the lower the likely error in generalizing the population.

#### **3.2. Data collection and variable selection**

This study is based on the secondary data extracted from annual reports of the company and the data library in

the Colombo Stock Exchange. The share price is collected from data library on Colombo Stock Exchange. Indicators of financial performance are collected from financial statements that are audited financial statements published in CSE. Most of the studies use ROA, ROE, EPS, and ROI, ratios as measurements of financial performance. Therefore, it is a very strong point to state that these are the standard measurements used commonly to measure financial performance. Control variables are firm size and board Size. Those common measurements are also considered to identify the impact of financial performance on share price under the COVID-19 pandemic. The dependent Variable is the Average share price. Generally, the share price means the price of a single share of a number of saleable equity shares of a company (Musyoki, 2012). The share price is the value of the firm divided by the number of outstanding shares. The price of the shares is generally indicated the overall strength and health of the company (Ghauri, 2014). If a firm does not concern about the share price and its changes, it will be a reason for losing the ownership of the company because the competitors can take over the particular company easily (Andersson, Gärling, Hedesström, & Biel, 2012). Therefore, the share price is a key component that should be considered. Therefore, the relationship between financial performance and the share price has received considerable critical attention. The way of measures all variables of this study as follows:

Table 3.1: Variables

Variables	Dimensions	Measurement
-----------	------------	-------------

	Return on Assets	ROA = $\frac{\text{Net income}}{\text{Total Assets}}$
Financial Performance		
	Return on Investment	ROI = $\frac{\text{Net profit}}{\text{Cost of Investment}}$
	Earnings per Share	EPS = $\frac{\text{Earnings after tax}}{\text{Number of shares}}$
	Return on Equity	ROE = $\frac{\text{Net profit after tax}}{\text{Shareholder equity}}$
Control variable	Board size	
	Firm Size	Total Number of directors on the Board Natural logarithm of total assets

Share Price

Average Market Price

Sum of Share Price in Twelve  
Months  
12

---

*Source: Author Compiled*

### 3.3. Empirical Model

Based on the literature and the research objectives the following empirical model is developed.

$$\begin{aligned}
 \text{ASPI}_{it} = & \beta_0 + \beta_1 (\text{ROA})_{it} + \beta_2 (\text{ROE})_{it} + \beta_3 (\text{ROI})_{it} + \beta_4 (\text{EPS})_{it} + \beta_5 \text{Covid-19 dummy} \\
 & + \beta_6 (\text{ROA} * \text{Covid\_19dummy})_{it} + \beta_7 (\text{ROE} * \text{Covid\_19dummy})_{it} + \beta_8 (\text{ROI} * \text{Covid\_19dummy})_{it} + \beta_9 (\text{EPS} * \\
 & \text{Covid\_19dummy})_{it} + \text{eit}
 \end{aligned}$$

- Equation 01

### 3.4. Hypotheses Testing

The hypotheses testing is carried out using the results of the regression.

H<sub>1</sub>: The impact of Return on Assets on the Share Price during the COVID 19 is less/more pronounced.

H<sub>2</sub>: The impact of the Return on Equity on the share price during COVID 19 is less/more pronounced.

H<sub>3</sub>: The impact of the Return on Investment on the Share Price during COVID 19 is less/more pronounced.

H<sub>4</sub>: The impact of Earning per share on the share price during COVID 19 is less/more pronounced.

H<sub>5</sub>: The board size has a significant effect on the Share Price during the COVID 19.

H<sub>6</sub>: The firm size has a significant effect on the Share Price during the COVID 19.



#### 4. Results and Discussion

According to the Hausman specification test, the P-value of the model is 0.9949. The p-value is greater than the 5% level of significance. Hence, the null hypothesis of the random effect model is appropriate and it failed to reject at 5 percent of a significant level. The random effect model is considered the most appropriate model to examine the effect of financial performance on share prices. According to Random effect Regression analysis, Wald Chi2 value of the random effect model is 21.24 ( $P < 0.05$ ) which explains that the model is significant before COVID 19 pandemic. The R-square value of the random effect model is 0.0791 which explains that around 7.91% of the total variability of the model is explained by the average share price before COVID-19 pandemic.

Table 4.1: Model Summary

Average Share price	Coefficient	Std. err.	t	P >  t
Return on Assets	6.0271	2.9761	2.03	<b>0.043</b>
Return on Equity	1.4702	0.8678	1.69	<b>0.090</b>
Return on investment	-1.2151	0.6248	-1.94	<b>0.052</b>
Earnings per share	-1.3586	0.4167	-3.26	<b>0.001</b>
Dummy Variable	12.7365	14.1591	0.90	0.368
ROA*dummy variable	-5.4610	5.4490	-1.00	0.316
ROE* dummy variable	-1.6722	1.3736	-1.22	0.223
ROI* dummy variable	-0.2952	1.2783	-0.23	0.817
EPS* dummy variable	1.3853	0.8989	1.54	0.123
EPS* dummy variable	1.3853	0.8989	1.54	0.123
BS*dummy variable	-2.5811	2.0201	-1.28	0.064
Constant	66.4039	8.4918	7.82	0.000

---

sigma_u 11.81	Observation 240
sigma_e 41.95	R- squared 0.0791
rho 0.0735	F statistics (p- value) 21.24 (0.0116)

---

*Source: Author Compiled*

The  $\beta$  coefficient of Return on Assets is 6.0271 is significant ( $P = 0.043$ ) at 0.05 level of significance towards the share price in the financial sector for COVID-19 pandemic. It means that there is a significant impact on return on assets fluctuations but a significant positive impact on the average share price. The  $\beta$  coefficient of Return on equity is 1.4702. The impact is significant at 10% level of significance The  $\beta$  coefficient of Return on Investment is -1.2151 is significant ( $P = 0.052$ ) at 10% level. The  $\beta$  coefficient of Earnings per share is -1.3586 is significant ( $P = 0.001$ ) at 0.01 level of significance towards the share price in the listed banks, finance, and insurance sector in Sri Lanka in the COVID 19 pandemic. It means that there is a significant impact of Earnings per share fluctuations, but a significant negative impact on the average share price. The  $\beta$  coefficient of the dummy variable is 12.7365 but this is insignificant.

The  $\beta$  coefficient of the board size on the share prices during the COVID 19 is -5.4610. But this impact is non-significant. The  $\beta$  coefficient effect of Firm size on return on investment is -0.0036 during COVID 19. But this impact is non-significant

The result of multiple regression analysis indicates that there is a significant impact of financial performance on share price during the COVID 19 pandemic. But individual t- statistics of all independent variables are non-significant on average share price during the COVID-19 period. This means that the variables collectively have

predictive power, but it is not possible to determine the coefficients accurately. This usually happens due to a high positive or negative correlation among the variables.

All variables are non-significant on average share price during COVID 19. Additionally, the study tested the Granger Causality Test. The structures of the causal relationships between variables were analyzed using the Granger causality approach. The Granger causality test is a statistical test to determine whether one-time series is useful in predicting another. If the probability value is less than any level, then the hypothesis would be rejected at that level. Lopez and Weber, (2017) investigated the STATA user-written command xtgcause, which implements a procedure proposed by Dumitrescu and Hurlin (2012) for testing Granger causality in panel datasets.

H<sub>0</sub> : Independent Variables do not Granger-cause average share price

H<sub>1</sub> : Independent variables Granger-cause average share price

Table 4.2: Variables Summary

Average Share Price	Dumitrescu & Hurlin (2012) Granger non-causality test results
Dummy variable	Lag order: 1 W-bar = 7.1801 Z-bar = 19.5431 (p-value = 0.0000) Z-bar tilde = 10.4823 (p-value = 0.0000)
ROA*dummy	Lag order: 1 W-bar = 6.1599 Z-bar = 16.3171 (p-value = 0.0000) Z-bar tilde = 8.6533 (p-value = 0.0000)

ROE*dummy	Lag order: 1 W-bar = 3.3529 Z-bar = 7.4406 (p-value = 0.0000) Z-bar tilde = 3.6208 (p-value = 0.0003)
ROI*dummy	Lag order: 1 W-bar = 6.9695 Z-bar = 18.8772 (p-value = 0.0000) Z-bar tilde = 10.1047 (p-value = 0.0000)
EPS*dummy	Lag order: 1 W-bar = 6.2715 Z-bar = 16.6701 (p-value = 0.0000) Z-bar tilde = 8.8534 (p-value = 0.0000)
Board size	Lag order: 1 W-bar = 8.2335 Z-bar = 22.8744 (p-value = 0.0000) Z-bar tilde = 12.3709 (p-value = 0.0000)
Firm size	Lag order: 1 W-bar = 2.6498 Z-bar = 5.2171 (p-value = 0.0000) Z-bar tilde = 2.3602 (p-value = 0.0183)

---

*Source: Author Compiled*

As shown in the above tables, the p-values (Z bar) of the test for all variables are less than 0.05. There is sufficient evidence to reject the null hypothesis. Therefore, it can be concluded that those mentioned variables are Granger-cause average share price at its levels of significance during the COVID 19 pandemic. The results are consistent with the previous findings of Obeidat, (2009) who found a positive trend in the relationship between earning per share, book value per share, and the share price. Moreover, Wang, Fu, and Luo, (2013) found a positive significant relationship between ROE, EPS, and the share price with special reference to the listed companies on Shanghai

Stock Exchange in the year 2011. Wijesinghe and Senarathne (2011) showed that there is a significant positive impact of ASP on the ROA finance sector in Sri Lanka. Jensen, (1993) and Lipton and Lorsh (1992) revealed board size is increased the agency problem positively and significantly increases within the board. According to Ramaswamy (2001); Jermias (2008); Frank and Goyal (2004) big firms enjoy a number of benefits accruing from the economies of scale and they also have better resources than smaller firms.

## **5. Conclusion**

The conclusions of the study have been made by considering the results of this study to address the research questions. This study has considered 20 listed banks, finance and insurance companies in Sri Lanka for the period of 2018 -2020 for the purpose of this study. Correlation and multiple regression analysis and Granger causality test was used to determine the relationship and impact of financial performance on the share price of commercial banks in Sri Lanka respectively.

The first objective of the study is to determine the effect of return on assets on the share prices during the COVID-19 pandemic. Further ROA, ROE, ROI, EPS, Board Size, Firm Size have a causality relationship with average share price. As per the results of the Granger causality test, there is a significant impact of ROA, ROE, ROI, EPS, Board size, and Firm size on share prices which is consistent with the literature.

Future research can be used other proxies for measuring financial performances, for example; Debt Equity ratio, net interest margin, and dividend per share to measure financial performance. This study considered only 20

companies in the banking, finance, and insurance sector. Further research should develop by increasing the sample size, more variables and time period.

## 6. References

Almumani, 2014. The Impact of Accounting Variables on Stock Price: Evidence ... between EPS and share price behaviour.

Al-Qudah, A. A., Alsharari, . N. M., Al-Rjoub, A. . M. & Haddad, W., 2013. Importance of Financial Analysis for Published Financial Information to Predict the Stocks Behavior (Case study-ASE –Industrial Sector-Jordan). *European Journal of Business management*, 5(6).

McConella & Servaes, 2000. Agency Theory and Resource Dependency theory.

Adeniyi, A., 2008. *Management Accounting*. Lagos: Cooperate Publishers Venture..

Adongo, K. & Jagongo, A., 2013. .Budgetary Control as a Measure of Financial Performance of State Corporations in Kenya. *International Journal of Accounting and Taxation*, 1(1).

Al-Matari, E. M., Al-Swidi, A. K. & Fadzil, F. H. B., 2014. The Measurements of Firm Performance's Dimensions. *Asian Journal of Finance & Accounting*, 6(1).

Ansari:, 2013. The relationship of dividend policy with share market price; EPS; and firm performance.. *SAGE Journal*.

Arkan, T., 2016. The Importance of Financial Ratios in Predicting Stock Price Trends: A Case Study in Emerging Markets. *Zeszyty Naukowe Uniwersytetu Szczecińskiego Finanse Rynki Finansowe Ubezpieczenia*, pp. 13-26.

Baron, R. M. & Kenny, D. A., 1986. The moderator–mediator variable distinction in social psychological research: Conceptual, strategic, and statistical considerations. *Journal of Personality and Social Psychology*, 51(6), pp. 1173-1182.

- Clarke, T., 2004. Theories of corporate governance: The philosophical foundations of corporate governance. London: Routledge.
- Daily, 1996. Agency theory: the times, they are a-changin'". Management Decision.
- Donaldson, L. & Davis, J. H., 1991. Stewardship Theory or Agency Theory: CEO Governance and Shareholder Returns. Australian Journal of Management, 16(1), pp. 49-65.
- Eisenhardt, K. M., 1989. Agency Theory: An Assessment and Review. The Academy of Management Review, 14(1), pp. 1-18.
- Glezakos, 2012. The Impact of Accounting Information on Stock Prices: Evidence from the Athens Stock Exchange. International Journal of Economics and Finance, 4(2).
- Hillman, A. J. & Dalziel, T., 2003. Boards of Directors and Firm Performance: Integrating Agency and Resource Dependence Perspectives. The Academy of Management Review, pp. 386-396.
- Jensen, M. & Meckling, W., 2002. Value maximization, stakeholder theory, and the corporate objective function. Business Ethics Quarterly, Volume 12.
- Johnson, B. L., 1995. Resource Dependence Theory: A Political Economy Model of Organizations.. Sementric Scholar.
- Kabajeh, M. A. M., Nuaimat, . S. M. A. A. & Dahmash, F. N., 2012. The relationship between the ROA, ROE and ROI ratios with Jordanian insurance public companies market share prices. Int. J. Humanit. Soc. Sci, 11(2), pp. 115-120.
- Kalyanaraman, L. & Tuwajri, B. A., 2014. Macroeconomic Forces and Stock Prices: Some Empirical Evidence from Saudi Arabia. International Journal of Financial Research, 5(1).
- Lambert, R. A. & Larcker, D. F., 1987. An Analysis of the use of Accounting and Market Measures of Performance in Executive Compensation Contracts. Journal of Accounting Research, Volume 25, pp. 85-125.

- Lopez, L. & Weber, S., 2017. Testing for Granger causality in panel data. University of Neuchatel (Institute of Economic Research).
- Malhotra, N. & Tandon, K., 2013. Determinants of Stock Prices: Empirical Evidence from NSE 100 Companies.
- Mehr-un-Nisa & Nishat, M., 2011. The Determinants of Stock Prices in Pakistan. Research gate.
- Menaje, P. M., 2012. Impact of selected accounting and economic variables on share price of publicly listed banks in the Philippines from 2002-2008. *DLSU Business and Economics Review*, 22(1), pp. 35-62.
- Musyoki, D., 2011. "Changes in share prices as a predictor of accounting earnings for financial firms listed in Nairobi Securities Exchange. *International Journal of Business and Public Management*, 2(2), pp. 1-11.
- Naceur, S. B., 2003. The Determinants of the Tunisian banking Industry Profitability: Panel Evidence. Research gate.
- Obeidat, M. . I., 2009. The Internal Financial Determinants of Common Stock Market Price: Evidence from Abu Dhabi Securities Market. *Journal of Economic and Administrative Sciences* , pp. 21-46.
- Padilla , A., 2002. Can agency theory justify the regulation of insider trading?. *The Quarterly Journal of Austrian Economics*, Volume 5, pp. 3-38.
- Podariu, S., Daly, R. A. & Mory, M. P., 2003. Agency Theory and Stewardship Theory Integrated, Expanded, and Bounded by Context: An Empirical Investigation of Structure, Behavior, and Performance within Family Firms.
- Preston, L., 1997. The corporate social-financial performance relationship. *Business and Society*, pp. 5-31.
- Rogers, P. J., 2008. Using Programme Theory to Evaluate Complicated and Complex Aspects of Interventions. *SAGE Journal*.
- Ruf, B. et al., 2015. An Empirical Investigation of the Relationship Between Change in Corporate Social Performance and Financial Performance: A Stakeholder Theory Perspective. *Journal of Business Ethics*, 31(3).



- Sharif, T., Purohit, H. & Pillai, R., 2015. Analysis of Factors Affecting Share Prices: The Case of Bahrain Stock Exchange. *International Journal of Economics and Finance*, 7(3).
- Sharma, S., 2011. Determinants of Equity Share prices in India. *Journal of Arts, Science and Commerce*, 4(2), pp. 51-60.
- Sindhu , M., Bukhari , S., Sub-Campus , B. & Hussain , A., 2014. Macroeconomic Factors do influencing Stock Price: A Case Study on Karachi Stock Exchange.. *J. Econ. Sustain. Dev.*, pp. 114-124.
- Sultana, S. T. & Pardhasaradhi, S., 2012. An Empirical Analysis of Factors Influencing Indian Individual Equity Investors' Decision Making and Behavior. *European Journal of Business Management*, 4(18).
- Wang, J., Fu, G. & Luo, C., 2013. Accounting Information and Stock Price Reaction of Listed Companies — Empirical Evidence from 60 Listed Companies in Shanghai Stock Exchange. *Journal of Business & Management*, 2(2), pp. 11-21.

## FACTORS DETERMINE THE DEMAND FOR MICROINSURANCE AMONG LOW-INCOME HOUSEHOLDS IN GALLE DISTRICT

Jaisa, M.J.S.<sup>1</sup> and Buddika, H.J.R.<sup>2</sup>

### Abstract

**Introduction-** Microinsurance is the product that concerns low-income households in the world. This study provides a summary of the research of factors determining the demand for microinsurance among low-income households in the Galle district. The purpose of this study is the analysis and identify which are the factors impacting the demand for microinsurance among low-income households.

**Design/Methodology/Approach-** The research is quantitative and regression analysis is used to find out the relationship between factors. The sample size is limited to the 250 low-income households in the Galle district and the random sample method used. Primary data are collected through well-designed questionnaires online and printed; the data were analyzed by using SPSS 23 software.

**Findings-** This research discloses that age, gender, marital status, occupation, income, expenditure, educational level, number of children in the family, knowledge about microinsurance trust on microinsurance are determining the demand for microinsurance. This study gives more information about major factors that determine the demand for microinsurance among low-income households and provides some recommendations for getting decisions about increasing the population of microinsurance in the Galle district.

**Conclusion** – Based on research findings it is proved that low-income householders have microinsurance for a certain level and the majority do not aware. Therefore, the insurance companies who target the low-income householders must focus on the methods of popularising the brand and promotional activities to get higher involvement of them.

**Keywords:** *Microinsurance, Low-Income, Galle, Demand Factors*

#### Cite this paper as:

Jaisa, M.J.S. and Buddika, H.J.R. FACTORS DETERMINE THE DEMAND FOR MICROINSURANCE AMONG LOW-INCOME HOUSEHOLDS IN GALLE DISTRICT. *10<sup>th</sup> Students' Research Symposium, Department of Finance, University of Kelaniya, Sri Lanka*. 6. 133-153

<sup>1</sup>Department of Finance, Faculty of Commerce and Management Studies, University of Kelaniya  
([Zeenathljaaisa@gmail.com](mailto:Zeenathljaaisa@gmail.com))

<sup>2</sup>Department of Finance, Faculty of Commerce and Management Studies, University of Kelaniya

## **1. Introduction**

### **1.1. Background of the Study**

The protection of poor people against specific threats in exchange for premium payment is proportionate to the likelihood and costs of the risks involved (Cohen & Sebstad, 2005). Microinsurance is protection for poor and low-income people. Microinsurance covers different types of risks such as illness, accidental injuries, credits, death, natural disasters (earthquake, drought) and property loss. (theft, fire) (Premaratne, 2010). These all risks are insurable and Microinsurance coverage can get individual or group basis. When comparing general and long term insurance, microinsurance premiums are very lower than other insurance premiums. Microinsurance coverage is very simple and very easy to understand.

### **1.2. Importance of the Study**

Microinsurance plays a major role in the insurance industry. Insurance companies try to protect against risk to consumers. Insurance companies must consider the factors affecting the demand for microinsurance among low-income households. Through that insurance companies can address these factors and insurance companies can improve their facilities. This research is very important to us because insurance companies can identify what factors are a more significant effect on factors determining the demand for microinsurance. As well as insurance companies can identify what factors need to be developed for potential consumers. There are many people in the Galle district in low-income households.

Factors determining the demand for microinsurance is the most popular topic in today's insurance industry. There are limited research findings on this topic and the findings of this research will add value to the microinsurance studies.

### **1.3. Research Problem**

Microinsurance is a new product in the insurance industry and it plays a major role in the insurance industry. In recent many poor people are willingness to buy microinsurance protection. Microinsurance protects poor people against risks to their lives, death illness, natural disasters, property losses etc. Under that insurance companies introduced new products such as death and illnesses insurance, disability insurance, health and life insurance, crop insurance, theft or fire insurance etc.

Most poor people in Galle district urban and rural areas do not have any microinsurance coverage. The problem is "Factors determine the demand of microinsurance among low-income households in Galle district" Researcher will concern about this problem by using information from poor people of Galle district.

### **1.4. Research Questions**

- Which factors will determine the demand for microinsurance?
- How does microinsurance impact low-income households?
- How does microinsurance help low-income households due to covid-19?

### **1.5. Research Objectives**

- To find out the factors that determine the demand for microinsurance.
- To find out how demographic factors affect on demand for microinsurance.
- To find out how to popular microinsurance among low-income households in the Galle district.
- To find out why does not microinsurance popular among low-income people in the Galle district.
- To find out the impact of microinsurance on low-income households.
- To find out how microinsurance helps poor people due to Covid-19.

### **1.6. Scope and Limitations**

- This study was limited to only a few people in the selected area. Therefore, this study will cover only a small portion of low-income people in Sri Lanka.
- There may be some difficulties when getting information from low-income people because of the due for Covid-19.
- This study, focuses only on 10 factors that impact the demand for microinsurance but there may be many factors that affect to demand for microinsurance.

## 2. Literature Review

Microinsurance protects specific market segments and it is not a specific product. When comparing microinsurance and general insurance the difference between these two is based on not just the products it is based on the accessibility of poor persons to insurance. Above 90% of the world's poor population in developing countries have no access to microinsurance (Biener & Eling, 2012).

Siegel et al., (2001) mentioned that the developing world microinsurance is a policy for poor people and it is increasing economic growth and development by providing a small scale. Morduch & Jonathan (2006) state that microinsurance is reducing the amount of money spent on replacing the loss of capital and disposable income. Microinsurance gives financial stability and maintenance by removing potential shocks or losses against too low-income households.

Microinsurance products are not high priced. They provide a high-quality product at a low premium. Once providing Microinsurance services, companies face some challenges when balancing the price and cost of microinsurance services. Microinsurance price covers all claims and operating expenses too (Gitau, 2013).

Chen et al., (2013) and Eling et al., (2014) examined that age group has a positive effect on the demand for microinsurance. Bhat & Jain, (2006) noted that in microinsurance schemes factors determine the demand for health insurance. They examined that the age group of a person is a positive effect on to demand for microinsurance. The age group showed a positive and significant impact on the probability of buying

microinsurance protection. Many researchers considered age as an adoption control variable. As well as income level, age, marital status, family sizes are determining the demand for microinsurance (Ndurukia et al., 2017).

Kansra & Pathania, (2012) States that there is no relationship between the gender of policyholder and awareness about microinsurance health insurance. According to that, there is no relationship between gender and awareness about health insurance. Thornton, et al., (2010) found that gender does not affect the demand for microinsurance.

Bhat & Jain, (2006) states that marital status has a positive impact on the demand for microinsurance. And also his research found people who got married take microinsurance protection mostly and family size is effective very little on demand of microinsurance.

Bhat & Jain, (2006) stated that the educational level of the policyholder is also important for an insurance buying decision. A higher level of educational level motivates buying insurance policies more. The educational level plays a major role in buying insurance policies in developing countries. The number of children in the family and expenditure level is significantly affected by the demand for health insurance (Bhat & Jain, 2006).

Low-income people don't have enough knowledge about microinsurance. Because of that increases the negative impact on the demand for microinsurance. Awareness of microinsurance and knowledge about microinsurance main determinants of demand for microinsurance (Tan, Allen, & Overy, 2012)

Ahsan, (2010) found that trust in microinsurance positive and significant effect on the demand for microinsurance

and also he noted one of the common elements is trust in the insurer. Premiums should be suitable for the willingness to pay clients.

There is a positive relationship between the demand for microinsurance and trust in insurance. Low-income households' trust is enhanced by the take-up of an insurance product (Chummun & Bisschoff, 2014).

### **3. Methodology**

#### **3.1. Introduction**

This chapter provides the research methodology that was used in collecting data for this study. The chapter presents the research design, conceptual framework, Hypothesis, target population estimation and sample techniques, data collection methods and procedures used. As well as sample questionnaires are also available.

#### **3.2. Research Design**

This research factual knowledge gets through observation with measurement. This will include how the researcher collects data, what will be used for collecting data and collected data. In this research, the researcher finds factors determining the demand for microinsurance among low-income households in Galle District. This research is quantitative and based on previous theories. This is a deductive research approach. In quantitative research design, we can identify the relationship between dependent and independent variables. And also this



study helps to determine the correlation between variables.

### **3.3. Conceptual Framework**

According to Bhat & Jain, (2006) the factors that determine the popularity of microinsurance such as age group, gender, marital status, education, income and expenditure are the most important. The knowledge about microinsurance and trust in microinsurance are most impacted by the popularity of microinsurance. Ahsan (2010) & Ellis (2000) these findings are based on this research. This model comprises dependent variables and independent variables as follows.

Figure 3.1: Conceptual Framework

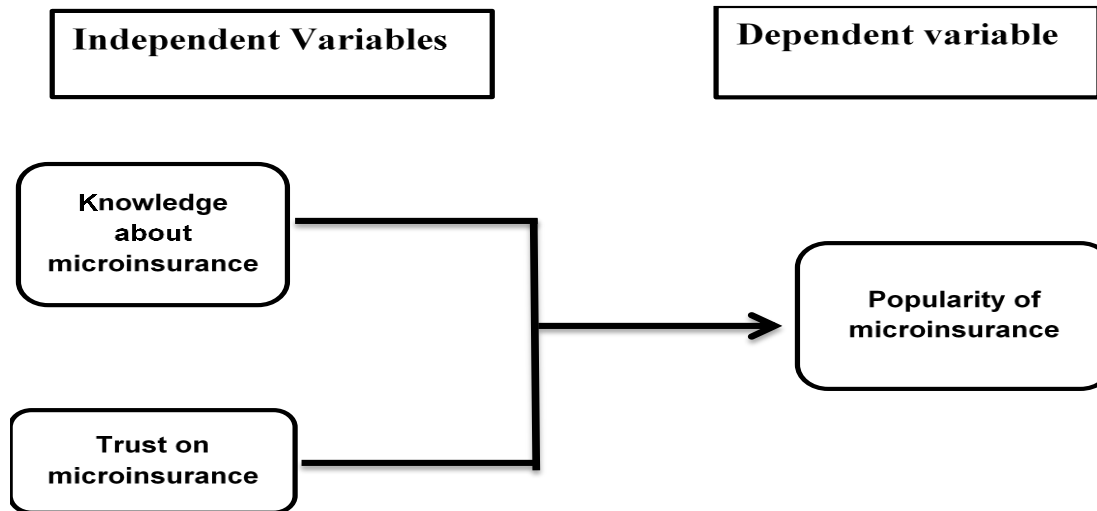

*Source : Author Compiled*

### 3.4. Hypotheses

H<sub>1</sub>: There is a significant impact on the popularity of microinsurance and knowledge about microinsurance for poor people

H<sub>2</sub>: There is a significant impact on the popularity of microinsurance and trust in microinsurance for poor people.

### **3.5. Population and Sample Design**

#### **3.5.1. Population**

This research studies factors determining the demand for microinsurance among low-income households in the Galle district. Data will be collected in urban areas from farmers, small entrepreneurs, estate workers, fishermen, and teachers and in rural areas from SME workers (garments, constructions etc.), Threewheeler drivers, carpenters, migrants, small entrepreneurs. (Global institute for tomorrow –GIFT) farmers and tea estate sector employers act a major role in the Sri Lankan economy.

#### **3.6. Data Analysis Methods**

There are eight demographic variables and the researcher studies how these variables affected the popularity of microinsurance. The researcher tested these 10 factors on the popularity of microinsurance by using regression analysis. The results of the analysis will range from -1 to +1. If it will -1 that means the perfect negative relationship between variables. If it will 1+ that means the perfect positive relationship between two variables and if it will 0 value that means no relationship between variables. This is quantitative research because the researcher used the statistical package of SPSS to analyze data. The data is organized in tables and charts to make data interpretation easy and clearly. A regression analysis test will use to test the hypothesis according to the topic. As well as correlation, the coefficient analysis will use to analyze the primary data of the study.

## 4. Findings and Discussion

### 4.1. Correlation Analysis

Table 4.1.1: Correlation

Variable	Pearson Correlation	P Value	Decision
Knowledge about microinsurance	0.715	0.000	H0 rejected
Trust of microinsurance	0.731	0.000	H0 rejected

*Source: Author Compiled*

The correlation coefficient describes the degree of relationship between independent variables and dependent variables. The range of correlation coefficient is -1 to +1. If the Pearson correlation is close to 0 means, there is no relationship between independent variables and dependent variables. If the Pearson correlations are close to -1 to +1 that means, there is a relationship between two variables.

The correlation between the popularity of microinsurance and knowledge about microinsurance is 0.715. And also the Correlation between the popularity of microinsurance and trust in microinsurance is 0.731. This result implies that these independent variables are correlated with each other. The correlations of the above variables are above 0.7. These variables are not highly correlated to measure the impact of the dependent variable.

## 4.2. Multiple Regression Analysis

Table 4.2.1: Coefficient table

Model	Unstandardized Coefficients B	Std. Error	Standardized Coefficients Beta	t	Sig.
(constant)	0.344	0.169		2.031	0.043
KM	0.355	0.054	0.328	6.524	0.000
TM	0.560	0.050	0.564	11.239	0.000

*Source: Author Compiled*

## 4.3. Knowledge About Microinsurance (KM)

$$Y = \beta_0 + \beta_1 + KM + \epsilon_i$$

Then,

Y = popularity of microinsurance

$\beta_0$  = Intercept

KM = knowledge about microinsurance

Therefore, a regression can have written as follows,

$$Y = 0.344 + 0.355KM$$

Without the impact of any other variable value of popularity of microinsurance is 0.344. Researchers can identify the impact of knowledge about microinsurance on the popularity of microinsurance.

Assume that other factors are remaining constant when knowledge about microinsurance increases one-unit popularity of microinsurance will increase by 0.355. There is a positive relationship between microinsurance and the popularity of microinsurance.

#### 4.4. Trust on Microinsurance (TM)

$$Y = \beta_0 + \beta_1 + TM + \epsilon_i$$

Then,

Y = popularity of microinsurance

$\beta_0$  = Intercept

KM = Trust in microinsurance

Therefore, a regression can have written as follows,

$$Y = 0.344 + 0.560TR$$

The relationship between the popularity of microinsurance and trust in microinsurance has a positive relationship and trust in microinsurance has the highest impact on the popularity of microinsurance than knowledge about microinsurance. Assume that other factors will remain constant trust of microinsurance increased by one popularity of microinsurance will increase by 0.560.

#### 4.5. Regression Results and Anova Table

Table 4.5.1.: ANOVA table

Model	Sum of square	df	Mean Square	f	
Regression	125.307	2	62.653	279.974	0.000 <sup>b</sup>
Residual	56.169	251	0.224		
Total	181.476	253			

*Source: Author Compiled*

According to the ANOVA test, the significant value of the regression model is 0.000. Because of that, the regression model of this study is significant.

## 5. Conclusion

### 5.1. Introduction

The main objective layout at the start of this research has been to identify the factors that determine the demand for microinsurance among low-income households in the Galle district. In the attempt to achieve this objective data was collected through questionnaires from low-income households. This research gives a summary of the

research and provides recommendations for identifying the factors which determine the demand for microinsurance.

## **5.2. Conclusion**

There are many people from low-income households who are lives in the Galle district who do not get any insurance policies. According to the research, only 110 people have insurance policies and the other 140 people don't have any insurance protection. The insurance companies must know the reasons for the less popularity of microinsurance and have to get action to increase the popularity of microinsurance. In this research, the researcher considers 10 factors that affect to demand for microinsurance. Such as age group, gender, marital status, occupation, monthly income, monthly expenditure, educational level, number of children in the family, knowledge about microinsurance and trust in microinsurance.

Researchers find out that age, gender, marital status, occupation, monthly income, monthly expenditure, educational level, number of children in the family have a dependent relationship with the popularity of microinsurance. Insurance companies can analyze the business with these factors. Then insurance companies can be predicting the popularity of microinsurance among low-income households in Sri Lanka.

There is a significant relationship between knowledge about microinsurance and the popularity of microinsurance. According to regression output, there is a strong relationship between knowledge about microinsurance and the popularity of microinsurance. If knowledge about microinsurance increases by 1



popularity of microinsurance will increase by 0.355. Therefore, insurance companies have to increase the knowledge about microinsurance among low-income households.

There is a significant relationship between trust in microinsurance and the popularity of microinsurance. According to regression output, there is a strong relationship between trust in microinsurance and the popularity of microinsurance. The trust in microinsurance increased by 1 popularity of microinsurance will increase by 0.560. Therefore, insurance companies have to increase the knowledge about microinsurance among low-income households.

### **5.3. Discussion**

According to data analysis, the researcher discusses the following special points. The researcher discusses some factors determine the demand for micro insurance in the literature review and methodology. Here researcher discusses ten factors that determine the demand for micro insurance by using regression. Researcher found through the research there is a relationship considered factors of age group, gender, marital status, education level, income, expenditure and number of children with the popularity of micro insurance. According to Uddin et al., (2017) Age groups, gender, marital status, Education depend on the demand for microinsurance. If someone wants to increase the demand for microinsurance in the Galle district according to this research should get action on other factors such as age group, gender, marital state, occupation, education level, income, expenditure level, number of children in the family knowledge about microinsurance and trust on microinsurance.

Researchers found that there is an impact of knowledge about microinsurance on the popularity of microinsurance. It implies that knowledge about insurance is significant factor to lower demand for microinsurance among low-income households.

Poor people's unawareness of microinsurance and less awareness about the importance of microinsurance can be the reason for the low demand for microinsurance. And also less knowledge about claim procedures and advantages, low knowledge about premiums and special characteristics of microinsurance than other insurance are effects decrease the demand for microinsurance among low-income households. According to data analysis, most of the age group above 50 people hasn't any insurance policy than others and most of the females also do not take any insurance coverage. Married people have dual incomes and they motivate to take insurance policies than single people. And also farmers and SME workers have the highest demand for microinsurance. The people who have income above 30000 also have the highest demand for microinsurance than other income category people. People who have University or College level education also have a higher demand for microinsurance than others. The number of children in the family and monthly expenditure also highly affect the demand for microinsurance. Ellis (2000) stated that evidence to the demand for microinsurance decrease with less knowledge about insurance. They find out that knowledge about microinsurance has a positive and significant impact on the demand for microinsurance. Those factors directly focused on the demand for microinsurance among low-income people.

Ahsan (2010) found that trust in microinsurance is significantly impacted by on-demand microinsurance. They

also said that it has a positive impact on the demand for microinsurance. These studies those are provided evidence to the popularity of microinsurance decreases with less trust in insurance. The lack of trust in insurance providers, insurance policies and claim procedures is mainly affected by to decrease in demand for microinsurance among low-income households.

#### **5.4. Recommendations**

Knowledge about microinsurance highly impacted the popularity of microinsurance. But in the Galle district, poor people have a low level of knowledge about microinsurance. So insurance companies have to increase the knowledge of low-income people. Therefore, insurance companies can conduct some awareness programs about microinsurance for enhancing the knowledge about microinsurance, claim procedures, advantages, the importance of microinsurance, benefits of microinsurance and newly products of microinsurance.

There is a significant relationship between trust in microinsurance and the popularity of microinsurance. The insurance companies have to increase trust in microinsurance among low-income households.

Insurance companies should train their employees to work with their consumers kindly. Insurance companies can provide low-income people with small and fair premiums. By giving transparency claim procedures to increase the trust of low-income households about microinsurance.

In the insurance market insurance companies must consider young ages, married persons, educated people, somewhat highly income people than other people in a poor society. By conducting awareness programs for

people about the importance of microinsurance, insurance companies can increase the social image of microinsurance image.

## 6. References

Ahsan, S. M. (2010). *Microinsurance, Poverty & Vulnerability: A Concept Paper*. Institute of Microfinance.

Bhat, R., & Jain, N. (2006). Factoring affecting the demand for health insurance in a micro insurance scheme.

Biener, C., & Eling, M. (2012). Insurability in microinsurance markets: An analysis of problems and potential solutions. *The Geneva Papers on Risk and Insurance-Issues and Practice*, 37(1), 77–107.

Chen, K., Hu, W., Xiao, C., & Xing, L. (2013). Smallholder participation in hog insurance and willingness to pay for improved policies: Evidence from Sichuan province in China. *ILO Microinsurance Innovation Facility Research Paper*, 28.

Cohen, M., & Sebstad, J. (2005). Reducing vulnerability: The demand for microinsurance. *Journal of International Development: The Journal of the Development Studies Association*, 17(3), 397–474.

Eling, M., Pradhan, S., & Schmit, J. T. (2014). The determinants of microinsurance demand. *The Geneva Papers on Risk and Insurance-Issues and Practice*, 39(2), 224–263.

Gitau, F. W. (2013). *Challenges facing development of micro insurance at CIC Insurance Group limited in Kenya*. University of Nairobi.

Kansra, P., & Pathania, G. (2012). A study of factor affecting the demand for health insurance in Punjab. *Journal of Management and Science*, 2(4), 1–10.

Ndurukia, Z., Njeru, A. W., & Waiganjo, E. (2017). Factors influencing demand for micro insurance services in the insurance industry in Kenya. *International Journal of Academic Research in Business and Social Sciences*, 7(7), 232–259.

Premaratne, S. P. (2010). Sector Study on Micro Insurance in Sri Lanka. Unpublished Thesis), University of Colombo. [https://doi.org/10.13140/RG.2\(18790.83523\)](https://doi.org/10.13140/RG.2.18790.83523).

Siegel, P. B., Alwang, J., & Canagarajah, S. (2001). Viewing microinsurance as a social risk management instrument. Citeseer.

Uddin, K., Gough, R., Radcliffe, J., Marco, J., & Jennings, P. (2017). Techno-economic analysis of the viability of residential photovoltaic systems using lithium-ion batteries for energy storage in the United Kingdom. *Applied Energy*, 206, 12–21.

Kansra, P., & Pathania, G. (2012). A study of factor affecting the demand for health insurance in Punjab. *Journal of Management and Science*, 2(4), 1–10.

Ndurukia, Z., Njeru, A. W., & Waiganjo, E. (2017). Factors influencing demand for micro insurance services in the insurance industry in Kenya. *International Journal of Academic Research in Business and Social Sciences*, 7(7), 232–259.

Premaratne, S. P. (2010). Sector Study on Micro Insurance in Sri Lanka. Unpublished Thesis), University of Colombo. [https://doi.org/10.13140/RG.2\(18790.83523\)](https://doi.org/10.13140/RG.2.18790.83523).

Siegel, P. B., Alwang, J., & Canagarajah, S. (2001). Viewing microinsurance as a social risk management instrument. Citeseer.

Uddin, K., Gough, R., Radcliffe, J., Marco, J., & Jennings, P. (2017). Techno-economic analysis of the viability of

residential photovoltaic systems using lithium-ion batteries for energy storage in the United Kingdom. Applied Energy, 206, 12–21.

**THE IMPACT OF COVID19 PANDEMIC ON THE PROFITABILITY OF THE INSURANCE INDUSTRY IN SRI LANKA**Thilakarathna U.H.L.<sup>1</sup> and Fernando. J.M.B.R<sup>2</sup>**Abstract**

**Introduction** -The main purpose of conducting this research is to examine the effect of the COVID-19 pandemic on the profitability of the insurance industry in Sri Lanka. At present COVID-19 pandemic is very crucial to the profitability of any industry. As a consequence, it is expected that this impact transposes into the nature and methods of insurance risky ventures, and thus drastically changes the business models of the insurance industry both in the short and long run. Despite the abundance of predictions and potential implications, the literature lacks investigations that target the short-run economic impact of the COVID-19 pandemic on the insurance industry.

**Design/Methodology/Approach** - The analysis is based on 10 insurance companies listed on the Colombo Stock Exchange and also the study is based on secondary data over a period of the past four years from 2018 to 2021. Correlation, regression analysis, and descriptive statistics were applied in the analysis. Firm size, premium growth, solvency ratio, Confirmed COVID Cases, Reinsurance dependency, Inflation, and GDP Growth were used as firm-specific factors and ROA was used to measure the profitability of the firm.

**Findings** – The study shows that there is a significant impact exists the between COVID-19 pandemic and the insurance industry's profitability.

**Conclusion:** The study provides directions for the management of the insurance sector of Sri Lanka in relation to its profitability dimensions during a pandemic. The proactive actions were taken by the insurance companies during the Covid-19 appreciated and it is highlighted how sensitive the profitability indicators for the chosen strategies.

**Keywords:** *COVID-19, Insurance Industry, Profitability*

**Cite this paper as:**

Thilakarathna U.H.L and Fernando, J.M.B.R. (2022). THE IMPACT OF COVID19 PANDEMIC ON THE PROFITABILITY OF THE INSURANCE INDUSTRY IN SRI LANKA. *10<sup>th</sup> Students' Research Symposium, Department of Finance, University of Kelaniya, Sri Lanka.* 7. 154-175

<sup>1</sup>Department of Finance, Faculty of Commerce and Management Studies, University of Kelaniya ([hiroshanilakmali97@gmail.com](mailto:hiroshanilakmali97@gmail.com))

<sup>2</sup>Department of Finance, Faculty of Commerce and Management Studies, University of Kelaniya

## 1. Introduction

The COVID-19 outbreak began in Wuhan, China at the end of 2019 and spread rapidly in many developed countries including the USA, Spain, Italy, the UK, and all over the world by May 2020. Although it does not appear to be slowing down across the globe nor is complete eradication of the virus in sight, governments are reacting in even more dramatic ways, closing borders, imposing lockdowns and travel restrictions, shutting schools and colleges, and banning mass gathering such as sporting events. COVID-19 is an increasingly severe pandemic that has a direct impact on the lives of individuals as well as corporate affairs. Due to the current pandemic, scholars have started to explore the effect of COVID 19 on several areas and on several industries. The impact of this corona pandemic affected not only one specific industry but the financial sectors of all industries. According to World Health Organization (WHO), the COVID pandemic has affected hotels, airlines, casinos and gaming, leisure facilities, oil and gas drilling, auto part and equipment, and many other large industries. Among them, the impact on the insurance industry is huge.

The insurance industry could be affected by the COVID-19 in two broad categories; premiums and claims. The impact on the profitability of the insurance industry can be clearly seen from the changes in those two broad categories. While it is clear that the claims might have skyrocketed due to increased unemployment (payment to unemployment insurance buyers), hospitalization (increased payments in case of health insurance policyholders), deaths (huge lump sum and annuity payments for life insurance), and business closures (payment against natural disasters), the impact on the premium is again expected to be twofold. First, there may be huge losses on premium



income due to reduced family, health, and life insurance sales resulting from a wide-scale lockdown with no direct interaction between salespersons and potential insurance policy buyers. Second, online insurance sales might boom due to the expanded health and life risks brought by the pandemic. People might want to hedge their huge payment risk due to potential illnesses caused by the epidemic or overall deteriorating health scenario. Correspondingly, raising unemployment insurance sales, and corporate insurance sales may increase the premium income of the insurance companies.

The elasticity of corporate insurance demand after a catastrophic occasion can explain if the insurance industry returns will be affected positively or negatively. One of the very few empirical papers on this critical topic uses the data on 1800 large U.S. corporations and concludes that the insurance industry exploits a boom in premium income after destructive incidents (Malik , 2011). Another study using 43 large catastrophic-insured events since 1970, finds a major increase in industry revenues and stock returns of insurance brokers, right after such incidents (Ragin, 2015). COVID-19 has had an austere negative impact on the Chinese insurance industry and caused a reduction in all kinds of inflows, including both commercial and individual premiums. The growth rate of gross premium brings down by 9.53% as compared with 2019.

With regard to the life insurance industry, with the advent of epidemics such as COVID-19, huge compensation has to be paid. This can greatly reduce profitability and lead to losses. The key issue present in most countries is to allow rapid testing of individuals, particularly people in the vulnerable population such as the elderly or those with underlying health conditions, especially compromised immune systems. In many countries this testing is free

(provide by the government) of the cost are being waived by healthcare providers and/or health insurers free treatment, however, is not universal and these costs can be substantial. So presently the trend is an economic recession with decreasing profits but increasing claims.

The key issue currently in most countries is to enable rapid testing of individuals, particularly people in vulnerable populations such as the elderly or those with underlying health conditions, especially compromised immune systems. In most countries, this testing is free (provided by governments) or the costs are being waived by healthcare providers and/or health insurers. Free treatment, however, is not universal and these costs can be substantial. Additionally, this has forced insurance companies to take multiple steps to stay relevant in these challenging times. With that insurance companies have also taken initiatives to prevent the spread of the Coronavirus by extending benefits to their policyholders.

When considering the current insurance industry in SL, Sri Lanka Insurance Corporation Limited has covered all health and insurance policyholders with COVID 19 tests, loss of life claim benefits, daily hospitalization cash benefits, and surgical and hospitalization due to COVID 19, Allianz Life Insurance Lanka Limited has introduced hospitalization expenses benefit, and Hospital daily cash for better protection against COVID 19, AIA Insurance Lanka Limited has given free COVID 19 cover for all policyholders, Union Assurance introduced free COVID 19 life cover and hospital cash benefits for quarantine treatments and Softlogic Life Insurance PLC also extended their benefits to pay all medical and life claims that relate to COVID 19.

## 2. Literature review

### 2.1. Covid-19 Pandemic

Currently, we are passing through an unprecedented time in human history. Despite all the technological and economic progress, we made, and the abundance of resources we have, everyone felt helpless at least for some period of time, in front of nature during the COVID-19 outbreak (Square, 2020). The global number of confirmed cases and deaths has surpassed 30 million and 1 million (as of 24th September 2020), respectively (WHO, 2020). The pandemic of COVID-19 has been spreading across the world. The expected economic consequences might be as severe as a 2% decrease in the global GDP. It means that almost every sector of the economy is threatened, including the insurance sector.

The current spread of the virus at a fast rate compared to the previous pandemics has resulted in a total lockdown of nations, a ban on travel, public gatherings, and closure of offices. There has been global closure of business as well as the loss of jobs and lives. The general economic situation is a global recession. Even though the fast increase in infection cases is greater than the recovery of infected people, the pandemic has overwhelmed many governments and financially weaken some insurance companies (Babuna et al., 2020). In Somaliland, the COVID-19 outbreak has forced many businesses and stores to close, leading to an unprecedented disruption of commerce in most industry sectors. Retailers and brands face many short-term challenges, such as those related to health and safety, the supply chain, the workforce, cash flow, consumer demand, sales, and marketing (Donthu &

Gustafsson, 2020). COVID-19 is likely to cause bankruptcy for many well-known brands in many industries as consumers stay at home and economies shut down (Stuckler & McKee, 2020). This not only has consequences for the economy; all of society is affected, which has led to dramatic changes in how businesses act and consumers behave (Donthu & Gustafsson, 2020). Most major industries faced large drops in the number of business owners with the only exception being agriculture. Construction, restaurants, hotels, and transportation all faced large declines in the number of business owners due to COVID-19 (Fairlie, 2020).

## **2.2. Insurance Industry**

Wang, Zhang, Wang, and Fu (2020) study is concerned with the health insurance schemes of selected companies in India in order to analyze the position of the individual company are to be calculated and also analyze the company's claims, settlements, and premiums. The objective of Plott's study in 2020 was to examine the growth in the health insurance industry. Under this study four standalone health insurance companies were selected for the period of five years from 2013-2014 to 2017-2018. The major findings drawn from this study are: that the major activity of insurance companies is underwriting; private insurance companies should reduce the impact of underwriting risk (amount of losses). To reduce underwriting risk firstly, the private insurance companies should improve their underwriting performance through the techniques of risk and product selections with geographical approaches and different pricing strategies according to the geographical and specific historical ground to determine the price of the same risk class or others. Secondly, to reduce the number of losses the company should also increase claims handling practices with continuous improvement on claim leakage management on both

sides, which is from the company employee (the engineering, inspection, and climate management department) and from the customer side, to do this the company should develop immediate investigation mechanism on reported claims with crossed confirmation mechanism, for the employee, when conducting post-risk assessment the employee should report online picture and video to confirm the post-risk assessment therefore, he/she send the back office assessor or database from the climate site at a time, for the customer, the climate report or declaration day should reasonably limit to notice the loss.

The private insurance company should improve its underwriting share in favor of the economic growth of the country by identifying the potential and priority direction of the overall economic activity and growth of the country. And it should include new insurance services development based on the economic direction.

Private insurance companies should increase their company asset. An increase in total assets such as the establishment of more branches and the adoption of new technologies enables an insurer to underwrite more policies which may increase the underwriting profit and the total net profit. In addition, increasing assets like a branch and toying Crain also minimize the cost of climate.

Finally, the study sought to investigate the determinant of profitability in private insurers company in Ethiopia. However, the variables used in the statistical analysis did not include all factors that can affect the profitability of private insurers' company in Ethiopian it only includes few firm specific and macroeconomic quantitative variables. Thus, future research shall conduct on the issue like impact of government regulation policy and other directives and non- financial determinant of insurance profitability such as management quality, efficiency and

productivity and etc. ( Lire & Tegegn , 2016).

### **2.3. Profitability of Insurance Industry**

Kaya (2015) examined the effects of firm-specific factors on the profitability of nonlife insurance companies in Turkey. The analysis was done on a sample of 24 non-life insurance companies operating in the period 2006–2013 with profitability being measured with two different variables: technical profitability ratio and sales profitability ratio. Eight independent variables were tested in the study including size of the company, age of the company, loss ratio, insurance leverage ratio, current ratio, premium growth rate, motor insurance and premium retention ratio. The results show that the firm-specific factors affecting the profitability of Turkish non-life insurance companies are the size of the company, age of the company, loss ratio, current ratio, and premium growth rate. Specifically size and premium growth rate have positive effect on the performance, whereas all other variables significantly influencing performance have negative sign.

Batrinca and Burca (2014) analyzed the determinants of financial performance in the Romanian insurance market on a sample of 21 insurance companies during the period 2008-2012. Return on assets was employed in the model as the dependent variable while 13 explanatory variables (including firm-specific, industry-specific and macroeconomic variables) were tested using the multiple regression analysis. According to the findings, the determinants of the financial performance in the Romanian insurance market are leverage, size, gross written premium growth, underwriting risk, risk retention ratio and solvency margin.

Ying Lee (2014) investigated the effects of firm-specific and macroeconomic factors on the profitability of the property-liability insurance industry in Taiwan. Using the panel data of 15 insurers over 1999 through 2009, two dependent variables were employed in the model including operating ratio and return on assets to measure insurers' profitability. The results show that underwriting risk, reinsurance usage, input cost, return on investment (ROI) and the financial holding group have a significant influence on profitability in both operating ratio and ROA models.

There is also a great body of literature dealing with determinants of insurance companies' profitability in developed countries. For example, Doumpos, Gaganis and Pasiouras (2012) have analyzed performance of insurance companies from 91 countries in the period 2005-2009. Employing the preference ranking organization method for enrichment evaluations (PROMETHEE) II method, the authors employ seven financial performance variables such as equity to assets ratio, solvency ratio, technical reserves ratio, liquidity, ROA, etc., while determinants of performance include size, share.

#### **2.4. Relationship between the COVID pandemic and the Insurance industry's profitability**

Coronavirus disease 2019 (COVID-19) pandemic has placed unprecedented financial stress on most of the US health care system, including physician practices, emergency medical service systems, and hospitals. But there is one notable exception: health insurance companies. Sharp declines in elective care during the pandemic have reduced health care expenditures and contributed to earnings that are twice as large as those earned last year. For example, the United Health Group's net income during the second quarter grew from \$3.4 billion in 2019 to \$6.7

billion in 2020 and Anthem Inc's net income increased from \$1.1 billion to \$2.3 billion. Under the law, insurers must return a large portion of these excess revenues back to individuals, families, and employers. Insurers can keep only 15% or 20% of premiums for administration and profit; if they fail to spend the remainder on health services and efforts to improve quality, they must rebate the difference (Plott, 2020).

Various approaches have been implemented to investigate the impact of COVID-19 on the insurance industry. For instance, Mansour et al. (2020) used the patient perspective to propose improvements in the coverage of the health insurance class. Babuna , Yang , Gylbag, Awudi , Ngmenbelle, & Bian (2020) conducted interviews with representatives from the insurance industry in Ghana and found out that there is a trend of decreasing profits but increasing claims. Richter and Wilson (2020) developed a scenario analysis in which they evaluate and summarize the lessons learned from the pandemic crisis by baselining actual developments against a reasonable, pre-COVID-19 scenario.

Several studies have been conducted on the subject matter of COVID-19 and insurance industry's profitability. All the above studies provide us a solid base and give us an idea regarding relationship between insurance industry and COVID-19 pandemic. With regards to the literature used in this research it has been discussed about concepts of COVID-19 pandemic, Insurance industry, Profitability of Insurance industry and Relationship between COVID pandemic and Insurance industry's profitability.



### **3. Research Methodology**

#### **3.1. Population and the sample**

The population of this study is all Sri Lankan insurance companies. The main objective of this research is to monitor the impact of COVID-19 epidemic on the Sri Lankan insurance industry, only the local insurance companies are used as a population. As the sample for this study the insurance companies with the total annual revenue of over 1000 million is considered as the sample covering the general insurance and life insurance companies. The total sample size is 15 (9 general insurance companies and 6 life insurance companies).

#### **3.2. Empirical model**

This study mainly focuses on the profitability variables of insurance companies in Sri Lanka. This study used secondary data extracted from the published financial statements of the selected insurance companies for the period of five years, from 2018 to 2020. For obtaining information, study used the income statements and balance sheets of the selected insurance companies. In some cases, some data and information have been extracted from the websites of the sample firms. The data analyzed descriptively using tables, frequencies, percentages, correlation, reliability and regression analysis.

In line with the past literature a regression analysis was employed using the balance panel data method to examine the effect of COVID pandemic for insurance industry's profitability in Sri Lanka. Researcher developed

regression model using ROA as dependent variables and taking Premium Growth, Solvency Ratio, Firm Size, COVID 19 pandemic, Confirmed COVID ratio and Reinsurance Dependency.

The panel data is used in analyzing the impact of insurance industry's profitability, the basic frame work for the panel data is defined as per the following regression model.

$$Y = \alpha + \beta x + \mu$$

Where the dependent variable is denoted by (profitability) Y Intercept term used and denoted by  $\alpha$ , on the explanatory variables,  $\beta$  is a  $k \times 1$  vector of parameters to be estimated and vector of observations is  $x_{nt} \ 1 \times k, t=1 \ T: n=1, \dots, N$ . The functional form of the above model is as follows.

Profitability =  $f(\text{macroeconomic variables, insurance-specific variables, Covid\_dummy})$

$$\text{ROA}_{it} = \alpha + \beta_1 \text{Premium Growth}_{it} + \beta_2 \text{Solvancy}_{it} + \beta_3 \text{Firm size}_{it} + \beta_4 \text{Confirmed\_Covid case}_{it} + \beta_5 \text{Reinsurance\_dependency}_{it} + \beta_6 \text{COVID dummy}_{it} + \text{Inflation}_{it} + \text{GDPT}_{it} + \mu_{it} \quad \text{- Equation 01}$$

Where the Alfa ( $\alpha$ ) indicates the intercept coefficient in the regression equation and the beta ( $\beta$ ) indicates the slope coefficients of equation and the error term is indicated by the ( $\mu$ ).

## 4. Data presentation and analysis

### 4.1. Descriptive statistics

Descriptive statistics helps to understand the behavior of the variables. To provide a better understanding of the behavior of the variables, researcher utilized the descriptive analysis tools such as minimum, maximum, mean, standard deviation, skewness and kurtosis. Descriptive statistics can be divided into measures of central tendency and measures of variability, or spread. Measures of central tendency comprise the mean, median and mode, whereas measures of variability comprise the standard deviation or variance, the minimum and maximum variables of the entire independent, dependent variables to identify the behavior of entire variables of the study.

Table 4.1.1: Descriptive Statistics

	N	Minimum	Maximum	Mean	Std. Deviation	Skewness	Kurtosis
Premium	150	-0.430	0.640	0.044	0.185		
growth						2.555	0.7084
Solvency ratio	150	-0.185	0.860	0.035	0.123	1.786	0.4700

Confirmed							
COVID cases	150	0	0.02407	0.003	0.006457	0.436	0.0247
Firm Size	150	21.5436	24.9422	23.22	0.983896	1.701	3.7585
Reinsurance							
dependency	150	0	23.1506	2.32	6.911732	0.336	26.4028
Covid_Dummy	150	0	1	0.467	0.50056	0.932	1.9121
Inflation	150	0.03	0.06	0.044	0.00817	1.726	0.0312
GDP	150	-0.16	0.12	0.016	0.05668	3.112	0.2165
Return on							
Assets	150	-0.22505	2.35497	0.697	0.611893	1.507	2.3374

---

*Source: Author Compiled*

According to the Descriptive Analysis Minimum value of the premium, growth is -0.430. It has a 0.640 Maximum value and 0.044 Mean value. According to Table 4.1.1, the independent variable of the solvency ratio has a maximum value of 0.860 and its mean value is 0.035. The solvency ratio has a minimum value of -0.185. The confirmed COVID cases has a maximum value of 0.024 and its mean value is 0.003. The solvency ratio has a

minimum value of 0. The firm Size has a maximum value of 24.942 and its mean value is 23.22. The firm size has a minimum value of 21.543. Reinsurance dependency has a maximum value of 23.15 and it has a mean value of 2.320. The Standard Deviation is 6.911. The ratio of ROA has a mean value of 0.697 and it has a maximum value of 2.354. ROA has a minimum value of -0.225 and it has a 0.611 of standard deviation value. The Correlation analysis shows what kind of relationship between each of these dependent and independent variables. The below table summarizes the results of the correlation analysis of the current study.

Table 4.1.2: Correlation analysis

Variables		Correlations							
		Premium growth	Solvency ratio	Confirmed COVID cases	Firm Size	Reinsurance dependency	Inflation	GDP	Return on Assets
<b>Premium growth</b>	Pearson Correlation	1.00							
	Sig. (2-tailed)								
	N	150							
<b>Solvency ratio</b>	Pearson Correlation	-0.02	1.00						
	Sig. (2-tailed)	0.78							
	N	150	150						
<b>Confirmed COVID cases</b>	Pearson Correlation	0.13	-0.10	1.00					
	Sig. (2-tailed)	0.12	0.21						
	N	150	150	150					
<b>Firm Size</b>	Pearson Correlation	0.05	0.12	0.08	1.00				
	Sig. (2-tailed)	0.53	0.15	0.31					
	N	150	150	150	150				
<b>Reinsurance dependency</b>	Pearson Correlation	0.02	0.01	0.00	-0.08	1.00			
	Sig. (2-tailed)	0.76	0.88	0.99	0.34				
	N	150	150	150	150	150			
<b>Inflation</b>	Pearson Correlation	0.05	-0.12	.492**	0.07	0.00	1.00		
	Sig. (2-tailed)	0.55	0.14	0.00	0.42	0.99			
	N	150	150	150	150	150	150		
<b>GDP</b>	Pearson Correlation	0.02	0.05	.219**	-0.01	0.00	0.11	1.00	
	Sig. (2-tailed)	0.78	0.51	0.01	0.93	1.00	0.16		
	N	150	150	150	150	150	150	150	
<b>Return on Assets</b>	Pearson Correlation	0.09	0.12	0.06	.291**	.817**	0.01	-0.02	1.00
	Sig. (2-tailed)	0.27	0.13	0.49	0.00	0.00	0.89	0.85	
	N	150	150	150	150	150	150	150	150

*Source: Author Compiled*

According to the results of hypothesis test as shown in the Table 2, the correlation between premium growth and ROA positive value is 0.091. It indicates that there is a completely positive correlation between two variables. The correlation between Solvency ratio and ROA is 0.124. It indicates that there is a completely positive correlation

between two variables. The correlation between Confirmed COVID cases, a proxy for the Covid impact, and ROA is 0.057. It indicates that there is a completely positive correlation between two variables. The correlation between Firm Size and ROA is .291. It indicates that there is a positive correlation between the two variables. The correlation between Reinsurance dependency and ROA is .817. It indicates that there is a positive correlation between two variables. The correlation between Inflation and ROA is 0.01. It indicates that there is a completely positive correlation between two variables. The correlation between GDP and ROA is 0.01.

#### 4.2. Empirical results

In panel regression, the effect of COVID-19 epidemic on firm performance were measured. In this study, researchers obtained secondary data from annual reports. Panel data was analyzed by using the fixed-effect model and random effect model. Here, the researchers run the Hausman test for identifying the effect. According to Hausman test results, the random effect model of ROA was rejected ( $p=0.000$ ) therefore, the fixed effect model was accepted. This study has a fixed effect situation. The below table represents the results of fixed-effect GLS regression.

Table 4.2.1: Results of the Panel fixed effect model

Variable	ROA	
	Coefficient	P value

Premium growth	-7.798	0.000
Solvency ratio	1.329	0.186
Confirmed COVID cases	2.103	<b>0.007</b>
Firm Size	0.253	0.801
Reinsurance dependency	8.954	<b>0.000</b>
Covid Dummy	22.674	<b>0.000</b>
Inflation	1.520	0.131
GDP	-0.682	0.496
Chi-square	0.807	
Prob. Value	0.000	
Cross sectional fixed (dummy variable)	Yes	
R-squared	5.6310	
F-test	73.9120	
Prob> F	0.000	

*Source: Author Compiled*

According to the fixed effect model coefficient of Premium, growth is -7.798 and the significant value of 0.000 is lower than 0.05. So, the variable of Premium growth has a negative and significant impact on ROA. The Solvency



ratio is 1.329 shows a positive and insignificant (0.186) impact on ROA. According to the fixed effect model coefficient of Confirmed COVID cases is 2.103 and the significant value of 0.007 is lower than 0.05. So, the variable of Confirmed COVID cases has a positive and significant impact on ROA. Firm Size is 0.253 shows a positive and insignificant (0.801) impact on ROA. Reinsurance dependency is 8.954 shows a positive and significant (0.000) impact on ROA. GDP is -0.682 shows a negative and insignificant (0.131) impact on ROA. Inflation is 1.520 shows a positive and insignificant (0.496) impact on ROA. The overall R-squared of this model is 5.6310 and it represents a total variance of ROA from the independent variable of Firm-specific factors. Further, these results are significant at the 5% level. In this study, the hypotheses relating to covid-19 and reinsurance dependency are accepted.

## **5. Conclusions and Recommendations**

The outbreak of the COVID 19 pandemic has adversely affected global social and economic activities. This empirical study examines the impact of COVID-19 on the insurance market in Sri Lanka using the panel data and the fixed effect model. The findings reveal that COVID 19 has had a significant negative impact on Sri Lanka insurance marketing channels and the suppression of household insurance demand.

Mainly six hypotheses were formulated and they were tested based on regression analysis. Firm Size, Reinsurance Dependency, and Confirmed COVID Cases were supported by the results of these analyses and confirmed with previous research findings, moreover, the impact of the COVID 19 pandemic on the insurance industry's profitability is significant. Further, the results proved that independent variables (Premium growth, Solvency ratio, Confirmed COVID cases, Firm Size, Reinsurance dependency) make a positive impact on the insurance

industry's profitability. After identifying the main issues of this, we discussed the main objective of this research as to identify and assess the impact of COVID 19 pandemic on the insurance industry's profitability and to identify what implications should be taken for stakeholders to survive with Covid-19 pandemic. To achieve the main objective used panel regression. The study revealed that insurance specific variables influence the insurance profitability. Study found that model that are developed in order to examine the impact of variables on insurance performance were statistically sound.

This study proposes to conduct a cross-border study involving other countries in order to determine the impact of COVID 19 pandemic for insurance industry's profitability. In this study used as determinants the impact of COVID 19 pandemic for insurance industry's profitability ROA. Then future researcher can take more than these variables. This study considers only 3 year's information of annual reports of selected insurance companies from 2019-2021. And also sample size is 10. Future researcher can get many years than 3years. And can take more than 10 samples of companies. Another limitation of this study is only used secondary data of the companies. This study is used audited quarterly reports to the collect the data. But this study didn't use other documents which are prepared by the insurance companies. For the research purpose used secondary data method. Future researcher can collect data using primary source.

## 6. References

- Babuna , P., Yang , X., Gyilbag, A., Awudi , D. A., Ngmenbelle, D., & Bian , D. (2020, August 10). The Impact of COVID-19 on the Insurance Industry. *International journal of Environmental Research and public health*, 2-14.
- batrinca, G., & BURCA1 , A.-M. (2014, January). The Determinants of Financial Performance in the Romanian Insurance Market. *International Journal of Academic Research in Accounting, Finance and Management Sciences*, Vol. 4, , 299-308.
- Donthu, N., & Gustafsson, A. (2020, September). Effect of COVID-19 on business and research. *Journal of business research*, 117, 284-289.
- Doumpos, M., Gaganis, C., & Pasiouras, F. (2012). Estimating and explaining the financial performance of property and casualty insurers: A two-stage analysis. *Journal of CENTRUM Cathedra: The Business and Economics Research Journal*, 5(2), 155-170.
- Fairlie, R. (2020, July 24). The impact of COVID-19 on small business owners: Evidence from the first 3 months after widespread social-distancing restrictions. *Journal Economics and Management strategy*, 1-14.
- Kaya , E. Ö. (2015, october 13). The Effects of Firm-Specific Factors on the Profitability of Non-Life Insurance Companies in Turkey. *International Journal of Financial Studies* ISSN 2227-7072, 510-529.
- Lire , A., & Tegegn , T. (2016). Determinants of Profitability in Private Insurance Companies in Ethiopia. *Journal of Poverty, Investment and Development*, Vol.26, 85-92.
- Malik , H. (2011, November 3). DETERMINANTS OF INSURANCE COMPANIES PROFITABILITY: AN ANALYSIS OF INSURANCE SECTOR OF PAKISTAN. *Academic Research International*, Volume 1, , 315-321.
- Plott, C. (2020, November 3). Unexpected Health Insurance Profits and the COVID-19 Crisis. *The JAMA Forum*, 1713.
- Ragin, M. (2015, February 24). Market Expectation Following Catastrophes: an Examination of Insurance Broker

Return. *Journal of Risk and Insurance*, 83, 849-876.

Square, R. (2020). COVID-19 and Insurance market returns in emerging and developed markets: A comparative study based on Wavelet methods .

Stuckler, D., & McKee , M. (2020, may). If the world fails to protect the economy, COVID-19 will damage health not just now but also in the future. VOL 26 .

WHO. (2020). Monitoring health for the sustainable development goals.

Wang, Y., Zhang, D., Wang , X., & Fu, Q. (2020). How Does COVID-19 Affect China's Insurance Market? 2350-2362.

Ying Lee , C. (2014). THE EFFECTS OF FIRM SPECIFIC FACTORS AND MACROECONOMICS ON PROFITABILITY OF PROPERTY-LIABILITY INSURANCE INDUSTRY IN TAIWAN. *Asian Economic and Financial Review*, 681-691.

## IMPACT OF ENTERPRISE RISK MANAGEMENT ON UNDERWRITING PROFIT OF INSURANCE COMPANIES IN SRI LANKA

Madhushan, T.S.<sup>1</sup> and Buddhika, H.J.R.<sup>2</sup>

### Abstract

**Introduction-** Enterprise risk management is the modern concept that was used by financial companies to manage their risk. This study was conducted to examine the impact of enterprise risk management on underwriting profit in insurance companies in Sri Lanka.

**Design/Methodology/Approach-** The secondary data was collected from the sample of nine insurance companies in Sri Lanka for the period of eight years from 2013 to 2020. The drawing sample data was tested using panel data regression inference the results throughout pool ordinary least square, fixed effect and random effect models.

**Findings-** The researcher used correlation analysis to measure the association between Enterprise risk management and underwriting profit.

**Conclusion** – According to the finding of this study chief risk officer, risk committee, independent board of directors, solvency margin, leverage and external stakeholders showed a negative relationship between underwriting profit and only size showed a positive relationship between underwriting profit. Moreover, the result of this study found that there was a significant negative impact from solvency margin on underwriting profit and, there was a significant positive impact on the size of underwriting profit in insurance companies in Sri Lanka.

**Keywords:** *Risk committee, Solvency Margin, Leverage, Underwriting Profit, Enterprise Risk Management*

#### Cite this paper as:

Madhushan, T.S. and Buddhika, H.J.R IMPACT OF ENTERPRISE RISK MANAGEMENT ON UNDERWRITING PROFIT OF INSURANCE COMPANIES IN SRI LANKA. 10<sup>th</sup> Students' Research Symposium, Department of Finance, University of Kelaniya, Sri Lanka. 8. 176-199

<sup>1</sup>Department of Finance, Faculty of Commerce and Management Studies, University of Kelaniya  
([tharindusankam@gmail.com](mailto:tharindusankam@gmail.com))

<sup>2</sup>Department of Finance, Faculty of Commerce and Management Studies, University of Kelaniya

## 1. Introduction

The insurance industry has become one of the fastest-growing industries in the last few decades the development of the global economy and the various needs of human society. Furthermore, the insurance industry has evolved due to the increased probability of unexpected events. That is the essence of the insurance industry (Njegomira & Marovic, 2012). Insurance has been a necessity for many years Protection of human life and property values (Njegomira & Marovic, 2012). Thus, insurance companies should be these risks are managed and companies need to have an effective risk management system to manage these risks.

Effective risk management aims to provide certification for organizational achievement Objectives and its financial goals as well as maximizing shareholder value. (Mohammeda & Knapkova, 2016), (Daud & Yazid, 2009). ERM focuses primarily on strategic risk, Bringing both operational risk and financial risk into one risk management Framework. (Eikenhout, 2015). ERM is a modern concept of risk management. It has emerged to prevent the shortcomings of traditional risk management and the cultural approach that helps it lead the organization to minimize uncertainties and seize opportunities.

In the insurance industry, underwriting profit is one of the critical measurements that is used to evaluate a company's performance (Lire & Tegegn, 2016). Among the foundation of effective insurance, the operation is the ability to underwrite well as poor risks selection results in significant losses and insurer failure (Browne & Kamiya, 2011). The insurance company must meet the minimum capital requirement known as risk-based capital

introduced by the Insurance Board of Sri Lanka for each insurance class. Risk-based capital requirements help to reduce the expected cost-efficiently (Cummin, Harrington, & Klein, 1995).

This study seeks recent evidence of a link between enterprise risk management and underwriting dividends. This study helps to minimize business risk management problems for insurance companies in their day-to-day operations or investment decisions. This study is evidence to identify the existence of the insurance company and its activities. This study will help enterprise risk management to identify how the insurance industry affects profit margins. The researcher identifies the specific reasons that affect insurance profits. Therefore, the results of these studies will guide enterprise risk management strategies and increase insurance companies' insurance profits.

This research will help other researchers to do other research based on this research. On the other hand, the researcher can gain knowledge about the enterprise risk management model and research methods. If the researcher intends to continue his or her professional service in the insurance sector, this research may be useful to insurance insurers and insurance officers. In doing this research, the researcher gained a great deal of knowledge about various aspects.

### **1.1. Research Objectives**

- To explore the association between ERM and underwriting profit.
- To investigate the impact of ERM on underwriting profit in the insurance industry in Sri Lanka.

## **2. Literature Review**

Enterprise risk management and underwriting profits have become important concepts in the insurance industry. They play a significant role in the performance of the insurance industry and its corporate image. This chapter aims to describe every aspect of the study entitled "Impact of Enterprise Risk Management on Insurance Profits of Insurance Companies" using the available literature.

### **2.1. Insurance industry**

The main industry incorporated under the financial sector is the insurance industry, which is a risk transfer system in which the insured transfers the cost of losses to another entity for payment. Also, insurance is an economic instrument in which a person pays a small amount (premium) and incurs an economic loss relative to the total value of the risk.

Therefore, companies in the insurance industry should pay close attention to their risk management. Therefore, insurance is one of the most popular types of risk management.

Today the insurance industry has become one of the most competitive and popular industries in Sri Lanka. There are 27 insurance companies established in Sri Lanka. Insurance companies in Sri Lanka provide various covers to protect human life and property such as medical cover, motor insurance, fire insurance.



Risk can be simply defined as the possibility of something unpleasant or inappropriate happening. (Eikenhout, 2015). In another word, the risk is the uncertainty associated with a future outcome or event. Two types of risks are faced by insurance companies, which are financial risk and non-financial risk. Over the past few decades' financial risks become more important than non-financial risks.

## **2.2. Risk management**

Risk management is the process by which an organization identifies the risk of loss and selects the most appropriate method to treat that exposure. (Rejda, 2008). Risk management aims to provide decision-makers with a systematic approach to coping with risk and uncertainty. (Eikenhout, 2015).

Risk management is a combination of four functions: planning, organizing, directing and controlling an organization's activities while minimizing the business losses of an organization at a reasonable price (Iulia, 2014). Risk management includes two main approaches, traditional risk management and enterprise risk management (Eikenhout, 2015).

The enterprise risk management approach is used differently to manage risk compared to the traditional risk management approach. It is integrated into a risk portfolio and integrates into one complete risk management framework with strategic and operational risks and financial risks (Eikenhout, 2015).

### **2.3. Enterprise risk management**

ERM is a holistic approach to managing both operational and strategic risk across an organization and is a new inspiration for managing the risk collection that an organization faces. The primary objective of ERM is to assist management in dealing with uncertainties, managing risk and creating opportunities for value addition. Also, ERM aims to go beyond the basic intensity of meeting compliance standards to achieve true economic value. That is the ultimate goal of ERM. (Altuntas, Berry-Stolzle, & Hoyt).

Furthermore, ERM has an impact on the strategic decision-making process, affecting a company's returns, market diversification, service delivery, etc., and eventually, ERM has become part of the corporate culture (Daud & Yazid, 2009). The study identifies seven factors as the dimensions of the ERM, including the presence of the Chief Risk Officer, the presence of the Risk Committee and the independence of the Board of Directors, the marginal margin, the size, the leverage and the external stakeholders.

### **2.4. Chief Risk Officer**

A person or group of persons are needed to coordinate and take responsibility for the entire ERM program as well as communicate the goals and results to the board of directors. (COSO, 2004). Attributes of a successful CRO include risk awareness, knowledge of key business processes, current education in the risk management curriculum, communication skills including the ability to work closely with people of all walks of life, and appropriate skills in insurance, finance and accounting.

## **2.5. Presence of risk committee**

The Risk Committee is important for the insurer to define its risk appetite and to establish a proper risk management system for the proper functioning of the Risk Committee (Whalley & Wong, 2016). The presence of a risk committee is also a good indicator of the implementation of ERM (Aebi, Sabato, & Schmid, 2011).

## **2.6. Independence board of directors**

Independence of the Board of Directors Management is a key factor affecting the supervisory efficiency of the Board (Beasley, Richard, & Dana , 2005). The higher percentage of the independent board of directors' influence generates higher profitability for the company (Beasley, Richard & Dana, 2005).

## **2.7. Solvency margin**

One indicator of financial sustainability is the margin of settlement. It can be defined as the fair value of an insurance company's assets exceeding its liabilities and other comparable liabilities. (Authority, 2012). Solvency margin can be calculated by net assets divided by net written premiums (Hailegebreal , 2016). According to studies done by (Charumathi, 2012) there was a significant positive relationship between solvency margin and profitability.

## **2.8. Firm size**

Larger companies can write insurance premiums than smaller companies because small companies cannot protect

their clients in the event of a major risk or major disaster. Furthermore, large insurers can reduce operating costs as a result of the increase (Lire & Tegegn, 2016). (Lire & Tegegn (2016) pointed out that there was a significant positive correlation between size and profitability.

## **2.9. Leverage**

Lever refers to the ability of insurance companies to manage their economic exposure to uncertainties (Charumathi, 2012). A high lever adversely affects insurance profits. Previous research has shown that there is a negative relationship between profitability and insurance leverage (Charumathi, 2012), (Eikenhout, 2015).

## **2.10. External stockholders**

Pressure from external stakeholders is a critical force behind the implementation of ERM (Lam & Kawamoto, 1997). The higher the percentage of corporate equity, the more likely companies are to engage in ERM. (Hoyt & Liebenberg, 2011).

## **2.11. Underwriting profit**

The most important concept in the insurance industry is underwriting, which allows insurers to classify risks and set prices accordingly. Among the cornerstones of a successful insurance campaign, good risk writing ability and poor risk selection results in significant losses and insurance failure (Browne & Kamiya, 2011). Insurance profit can be defined as the profit that an insurance company makes after claims and expenses.

The measure of the success of an insurance company is the insurance profit. Based on theoretical and empirical evidence, the researcher could not identify the variables that affect insurance profits and the extent to which ERM dimensions affect insurance profits in the Sri Lankan context.

### **3. Research methodology**

#### **3.1. Conceptualization**

This model includes the independent and dependent variables. Here underwriting profit is the dependent variable and Enterprise Risk Management is the independent variable. As an independent variable; seven factors can be identified under the Enterprise Risk Management including the presence of a Chief risk officer, the Presence of a Risk Committee, Independence of the board of directors, Solvency Margin, Size, Leverage and External stakeholders.

#### **3.2. Research approach**

An appropriate research approach should be selected to find out solutions for the research questions. In this approach sufficient sample size should be selected to generalize the result of the study and this approach is most applicable for quantitative studies (Saunders, Lewis, & Thornhill, 2009). As the researcher attempts to test the existing theories related to underwriting profit and Enterprise Risk management and this is a quantitative study this study was used the deductive approach.

#### **3.3. Research design**

According to Saunders et al., (2009) research design is the general plan about how a researcher will go about answering the research questions. There are three major types of research designs. They are exploratory, descriptive and explanatory research designs. Exploratory research design is which provides insights to the researcher. An explanatory research design was used to conduct this thesis as the main purpose of this study is to explain the causal relationship between ERM and underwriting profit.

### **3.4. Site selection**

- Sri Lanka Insurance Corporation Ltd
- Union Assurance
- Amana Takaful PLC
- Ceylinco Insurance Ltd
- HNB Insurance Ltd
- Janashakthi Insurance PLC
- Softlogic Life Insurance PLC
- People's Insurance

- Arpico Insurance PLC
- Softlogic Capital PLC

For this study, only secondary data were used. Secondary data can be defined as the data which have already been collected by another party for another intention (Saunders et al., 2009).

The population of the Study. As per the words of (Saunders et al., 2009) population is the all set of cases in which a sample is taken. The target population of this study is all insurance companies in Sri Lanka. The sample size is based on the following criteria:

- The availability of consistent financial reports and accounts.
- The insurance companies have both general and life insurance.

Based on the above criteria ten insurance companies were selected to collect data which were before segregated insurance companies were selected to do this analysis.

### **3.5. Method of Data Analysis**

In the main information was analyzed victimization Descriptive Statistics, Pearson Correlation and regression analysis Eviews 12 version software Microsoft excel out. It had been accustomed analyse monetary information and especially just in the case of pooled information.

- Descriptive Statistics
- Correlation Analysis
- Panel Data Regression Analysis
- Pooled Ordinary Least Squares (OLS) Regression
- Multiple regression models
- Hypothesis

#### **4. Findings and Discussion**

This chapter focus on the analysis of data, collected from the annual reports of the 08 listed companies in CSE, companies were selected from the one sector in CSE as Insurance. The data were entered into Microsoft excel and E views statistical software to make the analysis process convenient. After that, the data were arranged according to the requirements. Further, the behaviour of both independent (CRO, RC, IBD, SM, LEV, SIZE, and ESH) and dependent (Underwriting Profit) variables are analyzed from the tables and graphs presentation. Data presentation, Descriptive, Correlation, multicollinearity test and regression are used to analyze the information is collected from the annual data of the selected companies.



#### 4.1. Correlation Analysis

It is an important technique that can be used to identify the association between two variables. It can use as a tool to analyze the relationship between the independent variable and dependent

variable. The following tables describe the correlation with independent variables of CRO, RC, IBD, SM, SIZE, LEV, and ESH dependent variable of UP separately.

Shows the correlation and probability between the enterprise risk management and Underwriting Profit. The presence of the Chief Risk Officer, Presence of risk committee, an Independent Board of directors, Solvency Margin, Leverage, and External Shareholders are represented by Enterprise risk management. When comparing overall results of the UP of CRO, SIZE, and LEV have positive correlation with UP. And other variables have negative correlation with UP. But only significant probability value is represented by SIZE and other all variables are insignificant under the 5% of level.

Table 4.1.1: Correlation Analysis

<b>Correlation Probability</b>	<b>UP</b>	<b>CRO</b>	<b>RC</b>	<b>IBD</b>	<b>SM</b>	<b>SIZE</b>	<b>LEV</b>	<b>ESH</b>
<b>UP</b>	1							
<b>CRO</b>	0.0856 0.4501	1						
<b>RC</b>	-0.0032 0.9977	0.1200 0.2890	1					
<b>IBD</b>	-0.1967 0.0802	-0.0578 0.6104	0.0092 0.9353	1				
<b>SM</b>	-0.1824 0.1053	-0.2798 0.1119	-0.0685 0.5456	0.1018 0.3684	1			
<b>SIZE</b>	0.6421 0.0000	-0.0880 0.4371	-0.2809 0.0116	-0.1205 0.2870	0.2666 0.0016	1		
<b>LEV</b>	0.0577 0.6111	-0.0554 0.6254	-0.0554 0.6254	-0.0453 0.6897	-0.2110 0.2870	0.2666 0.0168	1	

								<b>10<sup>th</sup> SRS - DFin</b>
<b>ESH</b>	-0.1906	0.1549	0.1549	-0.3173	-0.0673	-0.2044	-0.2546	1
	0.0903	0.1700	0.1700	0.0041	0.5529	0.0689	0.0227	

---

*Source: Author Compiled*

## **4.2. Regression Analysis**

The statistical procedure of regression analysis is used to estimate the impact between variables. When the priority is on the link between a dependent variable and one or more independent variables, it encompasses numerous approaches for estimating and evaluating multiple variables. Regression analysis, in particular, explains how the usual value of the dependent variable varies when one of the independent factors is changed while the other independent variables remain constant.

Shows the regression results of Solvency Margin, Firm size, Risk Committee, Leverage, Independent board directors, External stakeholders and, the presence of a chief risk officer and underwriting profit. The meaning of coefficient is, how will change the dependent variables when independent variables increased by one unit. R2 is a statistical measure that quantifies the amount of variance explained by an independent variable or variables in a regression model for a dependent variable.

Table 4.1.2: Regression Analysis

<b>Independent variable</b>	<b>Coefficient</b>	<b>St. error</b>	<b>t. statistic</b>	<b>Prob.</b>
<b>SM</b>	-0.205031	0.047568	-4.310312	0.0001
<b>SIZE</b>	0.648070	0.071380	9.079170	0.0000
<b>RC</b>	0.977437	0.369975	2.641901	0.0101
<b>LEV</b>	0.016948	0.041438	0.409010	0.6837
<b>IBD</b>	-0.843054	0.651332	-1.294354	0.1997
<b>ESH</b>	-0.322122	0.192844	-1.670378	0.0992
<b>CRO</b>	0.109918	0.187047	0.587650	0.5586
<b>R<sup>2</sup> 0.603279</b>				
<b>Constant 3.979322</b>				

*Source: Author Compiled*

### 4.3. Hypotheses Testing

H<sub>1</sub> : There is a positive impact with CRO and Underwriting Profit.

H<sub>2</sub> : There is a positive impact with RC and Underwriting Profit.

H<sub>3</sub> : There is a positive impact with IBD and Underwriting Profit.

H<sub>4</sub> : There is a positive impact with SM and Underwriting Profit.

H<sub>5</sub> : There is a positive impact with SIZE and Underwriting Profit

H<sub>6</sub> : There is a positive impact with LEV and Underwriting Profit.

H<sub>7</sub> : There is a positive impact with ESH and Underwriting Profit.

## 5. Conclusion

This section highlights the summarized results of this study. It is based on the methodology and research hypothesis.

According to the correlation results in Table 4.1.1, there is an insignificant relationship between all independent variables of CRO, RC, IBD, SM, SIZE, LEV, and ESH, and the dependent variable of Underwriting profit. The majority of Correlation values of independent variables are weakly correlated with underwriting profit. Based on the correlation analysis, a study has accepted the null hypothesis and rejected the alternative hypothesis under

the 5% of significance level. On the other hand, the researcher analyzes the regression analysis also to identify the impact of enterprise risk management and underwriting profit. The regression results of Table 4.1.2 shows that there is an insignificant impact with the dependent variable of UP with independent variables of LEV, IBD, ESH, and CRO. The majority of the Coefficients of the independent variables have a strong impact on underwriting profit. Based on the regression results, the researcher accepted the null hypothesis and reject the alternative hypothesis under 5% of the significance level. It means there is not any significant relationship between enterprise risk management and underwriting profit. Therefore, it can be concluded that there is no relationship between enterprise risk management and underwriting profit according to all findings.

### **5.1. Conclusion**

The study investigated the impact of enterprise risk management and underwriting profit concerning insurance companies in CSE considering the historical date from 2013 through 2020.

There is extensive empirical evidence on enterprise risk management around the world. The enterprise risk management of ten companies for Eight years are considered for the analysis based on the hypotheses. The main objective of the study is to investigate the relationship between enterprise risk management and underwriting profit. According to the overall results in the analysis chapter, the study can identify the relationship between enterprise risk management and underwriting profit and it indicates no significant relationship. So, as per the descriptive analysis, the researcher has identified the averages among the variables of enterprise risk management. Among the study, the researcher can achieve all objectives of the study.

## 5.2. Recommendation

After analyzing the findings, and finding out the impact of enterprise risk management on underwriting profit in insurance companies in Sri Lanka, the researcher presents the following recommendation. Underwriting profit is a major factor in the going concern of the insurance industry. Thus, it recommends the company managers put more effort into enterprise risk management, especially to manage the chief risk officer, risk committee, independent board of directors, solvency margin, size, leverage and external stakeholder. And also, the result of this study clearly shows that size and solvency margin are great predictors of insurance companies underwriting profit as they show an insignificant relationship.

Based on the above analysis researcher may further conclude that these results can be further strengthened if the firms manage their enterprise risk more efficiently. Further, a more aggressive policy toward enterprise risk management may not be able to generate more underwriting profit. Therefore, need adequate and accurate information from both internal and external sources to access the multiplicity of enterprise risks they face when presented with an insurance proposal. To manage enterprise risk appropriately, insurance companies should develop and implement adequate enterprise risk management strategies.

## 6. References

Acharyya, M., & Mutenga, S. (2013). The benefits of implementing Enterprise Risk Management:evidence from the non-life insurance industry.

Aebi, V., Sabato, G., & Schmid, M. (2011). Risk management, corporate governance, and bank performance. . Journal of Banking & Finance.

Altuntas, M., Berry-Stolzle, T., & Hoyt, R. (n.d.). Implementation of Enterprise Risk management: Evidence from the German property- Liability insurance industry.

Asemeit, O. C. (2014, 10). The Effect of Risk Management on Financial Performance of Insurance Companies in Kenya.

Authority, F. S. (2012, 05 10). Retrieved from Definitions of the financial ratios - solvency of life insurance. Retrieved from [http://www.finanssivalvonta.fi/en/Statistics/Insurance\\_market/Life\\_insurance/solvency/Pages/Definitions.aspx](http://www.finanssivalvonta.fi/en/Statistics/Insurance_market/Life_insurance/solvency/Pages/Definitions.aspx)

Beasley, M., Richard, C., & Dana , H. (2005). Enterprise Risk Management: An Empirical Analysis of Factors Associated with the Extent of Implementation. . Journal of Accounting & Public Policy 24.6,, 521-531.

Browne, M., & Kamiya, S. (2011). A Theory of The Demnd for Underwriting. The Journal of Risk and Insurance,, 1-15.



Charumathi, B. (2012). On the Determinants of Profitability of Indian Life Insurers An Empirical Study. Proceedings of the World Congress on Engineering .

COSO, C. o. (2004). Enterprise Risk Management – Integrated Framework. New York.

Cummin, J., Harrington, E., & Klein, R. (1995). Insolvency Experience, Risk Based Capital and Prompt Corrective Action in Property-Liability Insurance.

Dabari, I., & Saidin, S. (2015). Determinants influencing the implementation of enterprise risk management in the Nigerian banking sector. . International Journal of Asian Social Science, 740-754.

Daily, N. (2017/07/07).

Daud, N., & Yazid, A. (2009). A Conceptual Framework For The Adoption of Enterprise Risk Management in Government-Linked Companies. International Review of Business Research Papers Vol, 229-238.

Eikenhout, L. (2015). Risk Management and Performance in Insurance Companies.

Essert , H., & Ijaz, S. (2016). The role and function of insurance company board of directors’ risk committees.

Hailegebreal , D. (2016). Macroeconomic and Firm Specific Determinants of Profitability of Insurance Industry in Ethiopia. Global Journal of Management and Business Research: C Finance.

Higgins, M., & Thistle, P. (2000). Capacity Constaints and The Dayanamics of Underwriting Profit.

Hoyt, R., & Liebenberg, A. (2011). The value of enterprise risk management. *The Journal of Risk and Insurance*,

Investopedia. (2017).

Iulia, C. (2014). Comparative Study Between Traditional and Enterprise Risk Management – A Theoretical Approach. Management, Faculty of Economics and Business Administration, West University of Timisoara, Romania.

kahane. (1977).

Kamau, M. H. (2013). The relationship between underwriting profit and investment income for the general insurance industry in Kenya.

Kleffner, A., Lee, R., & McGannon, B. (2003, 02). The Effect of Corporate Governance on the Use of Enterprise Risk Management: Evidence From Canada. *Risk Management & Insurance Review*, vol 6,, 53-73.

Kopia, J., Just, V., Geldmacher, W., & Bubian, A. (2017). Organizational Performance and Enterprise Risk Management.

Lam, J., & Kawamoto, B. (1997). Emergence of the Chief Risk Officer.

Liebenberg, A., & Hoyt, R. (2003). Determinants of Enterprise Risk Management: Evidence from the Appointment of Chief Risk Officers. . *Risk Management and Insurance Review* 6, 37-52.

- Lire , A., & Tegegn, T. (2016). Determinants of Profitability in Private Insurance Companies in Ethiopia. *Journal of Poverty, Investment and Development*.
- Meulbroek, L. K. (2002). senior manager's guide to integrated risk management. *Journal of Applied Corporate Finance*, 56-70.
- Mohammeda, H., & Knapkova, A. (2016). The Impact of Total Risk Management on Company's Performance . *Procedia - Social and Behavioral* , 271-277.
- Njegomira, N., & Marovic, B. (2012). Contemporary trends in the global insurance . 134-142.
- Njegomira, V., & Marovic, B. (2012). Contemporary trends in the global insurance . 134-142.
- Obalola, M. A. (2014).
- Obalola, M., Akpan, T., & Abass, O. (2014). The Relationship between . *Research Journal of Finance and Accounting*, 152-160.
- Obalola, M., Akpan, T., & Abass, O. (2014). The Relationship between Enterprise Risk Management (ERM) and Organizational Performance: Evidence from Nigerian Insurance Industry. *Research Journal of Finance and Accounting*, 152-160.
- Pagach, D., & Warr, R. (2010). The Effects of Enterprise Risk Management on Firm Performance.

Rejda, G. (2008). . Principles of Risk Management and Insurance.

Shad, K., & Lai, F. (2015). A Conceptual Framework for Enterprise Risk Management Performance measure through Economic value Added. Global Business and Management Research: An International Journal, 1-11.

Sibindi, A., & Godi, N. (2014). Insurance sector development and economic growth: evidence from South Africa. Corporate Ownership & Control .

Usoof, M. H. (2017, 10 30). Daily FT. Retrieved from Recent trends and future of life insurance industry. Retrieved from : <http://www.ft.lk/article/119460/Recent-trends-and-future-->

Whalley, P., & Wong, B. (2016). Risk committee- Guidance note on Corporate governance. Hong Kong: Pricewaterhousecoopers Limited.

Yang, C. (2015). Insurers' Underwriting Result and Investment Risk-Taking Behavior - Evidence from U.S. Property and Casualty Insurance Industry.

## THE IMPACT OF ELECTRONIC BANKING SERVICE QUALITY ON CUSTOMER SATISFACTION DURING THE PANDEMIC PERIOD

Priyankara, W.M.<sup>1</sup> and Weligamage, S.S.<sup>2</sup>

### Abstract

**Introduction-** Due to Coronavirus spread in the community, customers looked for more and more electronic banking services other than traditional banking services during the pandemic period. This study aims to see the impact of electronic banking service quality on bank customer satisfaction during the COVID – 19 pandemic in Sri Lanka.

**Design/Methodology/Approach-** The study was based on the quantitative approach and used primary data targeting four commercial bank electronic banking services used customers and 182 electronic banking service holders included in the study.

**Findings-** Findings revealed that the electronic banking service quality dimensions such as reliability, assurance, security & privacy, ease of use variables have a significant positive impact and empathy dimension has a negative impact on customer satisfaction during the COVID – 19 pandemic periods in Sri Lanka.

**Conclusion –** Based on the findings of this study electronic banking service quality dimensions, commercial banks in the Sri Lankan banking industry should focus on reliability, assurance, security & privacy, ease of use, and empathy.

**Keywords –** *Electronic banking service quality dimensions, bank customer satisfaction, COVID – 19 pandemic periods, Sri Lanka.*

#### Cite this paper as:

Priyankara, W.M. and Weligamage, S.S. THE IMPACT OF ELECTRONIC BANKING SERVICE QUALITY ON CUSTOMER SATISFACTION DURING THE PANDEMIC PERIOD. *10<sup>th</sup> Students' Research Symposium, Department of Finance, University of Kelaniya, Sri Lanka.* 9. 200-223

## 1. Introduction

The COVID-19 pandemic is started in Wuhan, China, and after it rapidly spread over the world and major coursed was arising lockdown concept. In the year of 2020 march, a curfew was started within the countries and globally. Which

<sup>1</sup>Department of Finance, Faculty of Commerce and Management Studies, University of Kelaniya  
([manojpriyankarahot@gmail.com](mailto:manojpriyankarahot@gmail.com))

<sup>2</sup>Department of Finance, Faculty of Commerce and Management Studies, University of Kelaniya

resulted in the majority of economic activities tending to decrease. Coronavirus spread between the community, as resulted in banking customers looking for more and more electronic banking services other than the traditional banking services Hussaien, *et al.*(2020).

Further, the world health organization argues for possible actions for overcoming the disease. Such as handling live banknotes coursed to spread the virus continuously therefore WHO suggested contactless payment methods are favorable for avoiding this situation (WHO, 2020).

According to the KPMG (2020, November) bank report identified domestically significant four banks and their assets representing 63%. However, the public bank represented 39.9% of the total assets. On 30<sup>th</sup> June of 2020 banking total assets portfolio represented 11,688.5 Bn. It indicated COVID- 19 effect for the Sri Lankan banking industry. However, they observed digital banking widely embraced before the COVID-19, and customers will expect and demand the ability to self-serve.

Global banking M & A outlook report (2020) expressed valuation and profitability areas mostly imported in the overall banking sector. Customers are spending their time more variable in crowded public spaces therefore banks will need to have a way to conduct banking without physical interaction. On the other hand, electronic banking uses computers and telecommunications to enable banking transactions to be done by telephone or computer rather than through human interaction.

It includes features such as electronic funds transfer for detailed transactions, the outcome it teller machine

transactions, and Automatic payroll deposits and bill payments. Electronic banking service performance depends on service quality. It comprises five dimensions of service quality. The main factor that would influence the customer satisfaction of a country would be the service quality dimension of overall banking services Parasuraman, Zeithmal & Malhotra(2005). Throughout this study the researcher would test the electronic banking service related service quality and how would impact customer satisfaction and it defined as customer response to the perceived gap between prior expectations or experiences and actual performance of products or services consumed service quality is viewed as the general identification of a service firm as resulted outcome and performance with the customer's general perspective of how firm or banking or any other industry should performance.

In more general terms, this research study tries to fill the gap of the previous studies that investigate according to existing research studies conducted by various researches related to area of internet banking and customer satisfaction or M-banking and customer satisfaction and banking service quality and customer satisfaction during the covid-19 pandemic period likewise there is the number of studies that had been conducted for different countries. But, a research study especially for Sri Lanka and by combining all the factors that would influence e-banking service quality and the impact on banks customer satisfaction during the pandemic period is not available, and hope this study would give value addition to the academic readers for their further references when it's required.

Sri Lanka's banking sector faced an unfavorable situation during the covid-19 pandemic period. Because physical bank processes were restricted and some cities are lockdown. Therefore, electronic banking services are more appropriate for the overcome challenges. During this season banks provided electronic banking services on their name or logo. But,

overall electronic banking service providers' services quality is more suitable, and few service providers' quality of the service and not positive. Therefore, service quality depends on the service quality dimension and during this period many peoples stay in their homes. Furthermore, customer satisfaction is the major component of this research. Customer fulfills their expected requirements and actual performance may be very volatile. Then the purpose of this study is to during the covid-19 pandemic period, how do impact electronic banking service quality on customer satisfaction in Sri Lanka.

## **2. Literature Review**

Cabanillas, Leiva, & Guardia(2013) researched by examining the determinants of satisfaction with electronic banking. Using as an empirical framework that incorporates the structural equation model (SEM) hypothesis. Results provide evidence that the relationship between trust and in electronic banking and usefulness and satisfaction had a direct positive relationship.

The study of service quality dimensions that affect customer satisfaction was undertaken in Pakurar *et al.*(2019) using the SERVERQUEL model hypothesis and using the quite same variables which were used by Cabanillas, Leiva, & Guardia(2013). The model shows the following dimensions such as tangibles, responsiveness, empathy, reliability, assurance, financial aspect, access, and employee competence. This study shows customer satisfaction as the main core concept. They observed all the seven service quality dimensions positively significant towards the dependent variable (customer satisfaction).



Hammoud, Bizri, & Baba(2018) examined the impact of E-banking service quality on customer satisfaction in the Lebanese banking sector. They used a structural equation hypothesis module (SEM) to measure the relationship between indicators. Researchers suggest four service quality dimensions. Such as efficiency, reliability, security and privacy, responsiveness, and communication. Jindal & Sharma(2020) conducted a study on the usability of online banking in India during the COVID-19 pandemic period. Their hypothesis relies on the five online banking models. Like bill payment, mobile, and dish T.V recharge, payment of online shopping, payment of offline purchases, and transfer of money. Their empirical result shows that buyers feel is impacted by the model. They argued during the COVID- 19 pandemic period customers are feeling safety is a vital factor.

Shabbir, Rehma, & Shabbier(2016) conducted study of Combine Effect of Automated Services, traditional Services Quality on Customer Satisfaction and evidence-based on Pakistan banking sector. They chose three methods of automated services. Like automated teller machines, mobile banking, and internet banking. Their empirical study suggested in step with the Pearson correlation matrix module the link between ATM services and customer satisfaction was significantly positive. And other variables are positively significant with customer satisfaction and the special case as mobile banking and internet banking are highly correlated.

According to the empirical evidence of Kawimbe(2020) highlighted SERVQUAL hypothesis model accustomed to empirical results. The empirical model consists of 5 digital banking quality dimensions. Like Reliability, Responsiveness, Assurance, Security, Tangibles. The empirical result used three questions to measure all variable relationships. A

variety of electronic channels consist of the e-banking concept. Such as doing banking transactions through the internet, telephone, TV, mobile, and computer, etc. Researchers observed Lebanon's electronic banking is limited because they used only the internet and mobile telephone for doing banking transactions Hammoud, Bizri, & Baba(2018).

According to Worku, Tilahuk, & Tafa(2016) suggested E-banking concept can be defined in many ways. Bank information and service delivery by banks to customers then they use different delivery channels. It includes digital television, desktop or software, computer, and mobile phone. On the other hand, electronic banking is a system of doing transactions electronically and without the physically use of cash. It provided to enhancing the speed and delivery of services properly to the banking industry. Researchers observed E-banking is a sub-category under E-commerce and E-finance. The study examines internet banking, mobile banking, and other delivery channels like ATM, POS is E-banking sources. Ahamed(2020) study notable that the customer's desires and expectations of the banking services are growing with the technological advances and enhancements. E-banking tries to operate and conduct banking transactions personally at any location. Researchers identified Lebanon's electronic banking is confined to slow IT infrastructure development in the country. Balwin & Mauro(2020) and Wojcik & Loannou(2020) argue during the pandemic period banks noticed consumers shift towards digital or electronic banking services. Electronic banking offers customer services for a wider choice, convenience, control, and cost savings.

In the present field of marketing studies, customer satisfaction is one of the most important concepts. It is related to post-purchase phenomena such as attitude changes and repeat purchase style and loyalty of the brand. The feelings of customer satisfaction that arise define customers compare their perception of actual product or service performance

with expectations. On the other hand, the researcher pointed out customer satisfaction is post-consumption emotional related product or service. Their study observed five service quality dimensions. Such as efficiency, reliability, privacy, and security, responsiveness and communication significantly affected customer satisfaction rapid growth of the Jordanian banking industry has created a competitive industrial environment and banks move into new thinking to understand consumer perceptions and quality of service Hammoud, Bizri, & Baba(2018). According to Pakurar *et al.*(2019), they argue managers have to be willing to understand the gap between perception and expectations. Bank has to imperative needs in the competitive market to find techniques of improving the service quality. Shabbir, Rehma, & Shabbier(2016) observed customer satisfaction is a fundamental component of marketing theory and practices over the last three decades. However, customer satisfaction is emphasized and evaluated based on total consumption over time.

Ketema & Selassie(2020) was developed SERVQUAL basically with consider face to face experience over the timeframe. To quantify electronic service quality. Parasuraman, Zeithmal & Malhotra(2005) created a 22 item scale called the E-S quality model. Zeithmal, V A; Parasuraman, A; Malhotra, A(2002) introduced 7 dimensions of electronic banking service quality scale. (efficiency, fulfillment, reliability, privacy, responsiveness, compensation, contract). Zeithmal, Parasuraman, Malhotra(2000) recommended a few characteristics like efficiency, reliability, fulfillment, privacy, responsiveness, compensation. Haq & Awan(2020) found E-banking service quality can be measured through the EBSQ model. It consisted of reliability, privacy and security, web design, and customer service and support. E-banking creates serious privacy issues for the users as there are no personal interactions. They suggested classical studies related to service quality cannot be neglected and now service quality read as the electronic and digital aspect of quality of

services. Hussaien, *et al.*(2020) showed that service quality in banks can be divided into two sections like technological service quality and service quality.

According to Ketema & Selassie(2020) pointed out reliability is the bank will agreeably proceed as intended and reliably give a similar service. Pakurar *et al.*(2019) observed the reliability is at the first time service provide then organization perform correctly. Moreover, this definition showed organizations should be fulfilling promises and especially pay attention to the final result. Assurance indicates the attitudes of the employees and their behaviors and the staff's ability to provide friendly, confidential, courteous, and competent services Pakurar *et al.*(2019). Assurance has been defined as employees' sponsorship and knowledge of their ability to transfer confidence and trust to customers Parasuraman *et al.*(1994).

Empathy means is during the service provides time to customers than paying personal attention and caring. The core empathy is fluctuation because a customer is unique and special. The researcher used security, credibility, and access to measure empathy. empathy was more part includes care and customized consideration that a firm can give to its clients as far as communication, accessibility, and understanding of the service being given Pakurar *et al.*(2019).

Tetteh(2021) argue touches on making e-banking solution's ease of use more important. Solutions should be simple to use, fast and user-friendly. On the other hand, e-banking, a website provided ATM should enable customers to easily understand the procedure. According to Ketema & Selassie(2020) suggested the study empathy has been considered as an impacting factor of the model. It will automatically lead client's forwards to the utilization of alternative electronic banking services like mobile and internet banking.

Even though the fast development of the internet site the security concept is more interesting Kawimbe(2020). According to Warren & Brandeis(1890) privacy is a legal concept and the right to be left alone. Westin(1987) pointed out privacy can also mean the claim of institutions, groups, or individuals to determine for themselves how, when and to what extent information about them is communicated to others. Privacy can be categorized as information privacy, bodily privacy, territorial privacy, and communication privacy Davis S(1996).

### **3. Research Methodology**

Considering the literature as reviewed above, it is evidence that the electronic banking service quality dimensions are more vital to be concerned view about banking customer satisfaction in the context of this study. These previous studies have given a platform to conduct this study in arranging that the service quality dimensions are influenced by customer satisfaction. Based on the theoretical framework of the previous studies done in different countries, the study identified five service quality dimensions namely; reliability, assurance, empathy, security/privacy, and ease of use. When deliberating the reviewed empirical analysis above, the survey research design was used for this study. Thus primary data were collected using a structural questionnaire set based on the conceptual model. The main survey was carried out after running a pilot survey for pre-awareness of the reliability of the data collected through the questionnaire.

There are 23 licensed commercial operate banks in Sri Lanka at end of 2020, which consist of 2 state banks, 11 domestic banks, and 10 foreign banks. The population of the study consists of four leading bank customers in Sri Lanka. The researchers selected 182 customers for sampling to represent all four banks.

Figure 1: Conceptual framework

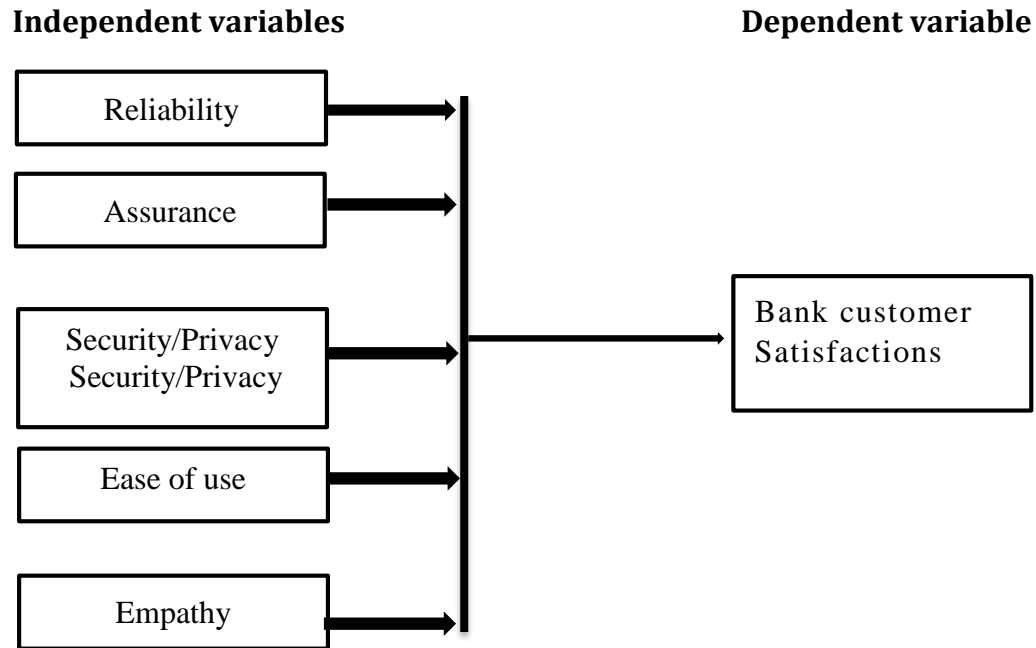

*Source: Develop by (Parasuraman, Zeithmal & Malhothra,2005)*

According to figure 1, bank customer satisfaction depends on five Independent variables: reliability, assurance, empathy, security/privacy, and ease of use of service quality dimensions also affect electronic banking service quality on customer satisfaction. Based on the above framework below hypotheses were developed.

**Hypothesis 1**

Reliability is an essential factor in the SERVERQUAL model, and researchers have shown that it can play an important role in inconsistent performance and trustworthiness. When investigating e-banking in Zambia, it is believed that this construct plays a local population's use of machine reliability rather than human reliability. It suggests its reliability positively influences customer satisfaction (Kawimbe, 2020).

H1: Reliability has a significant positive effect on customer satisfaction during the pandemic period.

**Hypothesis 2**

According to Pakurar *et al.*(2019) assurance dimension presents employees' trust competence and courtesy with customers. However, trust and confidence show a high level of customer satisfaction. They suggested that assurance and customer satisfaction have a positive relationship. Hussaien, et al.(2020) reported assurance and customer satisfaction to have a positive impact during the COVID-19 pandemic period in the commercial bank industry.

H2: Assurance has a significant positive effect on customer satisfaction during the pandemic period.

**Hypothesis 3**

Haq & Awan(2020) recorded privacy and security in e-banking services positively affect the customer's satisfaction. Kawimbe(2020) suggested internet influences for every customer when it comes to the security concept and he recorded security positively affected customer satisfaction. Because of this researcher expects the following hypothesis.

H3: Security/Privacy has a significant positive effect on customer satisfaction during the pandemic period.

#### **Hypothesis 4**

They recorded ease of use has a positive impact on customer satisfaction Cabanillas, Leiva, & Guardia(2013). Ahamed(2020) investigation of e-banking service quality on customer satisfaction in banks in Tripoli city and his resulted ease of use positively affected to the customer satisfaction. Therefore, this researcher expects the following hypothesis.

H4: Ease of use has a significant positive effect on customer satisfaction during the pandemic period.

#### **Hypothesis 5**

Empathy is an essential factor in the thee-SERVERQUAL model. Customers expect service accessibility, communication, and understanding of the service, and all facts include the empathy concept. They suggested empathy as an important factor in the E-SERVERQUAL model Ketema & Selassie(2020).

H5: Empathy has a significant positive effect on customer satisfaction during the pandemic period.

The researcher has used the statistical package for social science (SPSS) software to perform both descriptive and advanced data analysis. Cronbach's-alpha test is used to test the reliability of 22 items, which have been categorized under six heads. Method of scaling- Likert scale is very common in the questionnaire because of its ease to construct, high reliability, and successful adaptation to measure many types of characteristics. According to mentioned in the research design researchers used this scaling model and below Multiple and simple linear regression estimated regression equations



**Multiple regression function**

$$Y^{\wedge} = \beta_0 + \beta_1X_1 + \beta_2X_2 + \beta_3X_3 + \beta_4X_4 + \beta_5X_5 + \alpha \quad (1)$$

$Y$  = Customer satisfaction.

$X_1$  = Reliability.

$X_2$  = Assurance.

$X_3$  = Security & Privacy.

$X_4$  = Ease of use.

$X_5$  = Empathy.

**4. Findings and Discussion**

The process of summarizing collected data via primary sources to make the decision and clear identification of the research question can be identified as the data presented. Before the move to the analyzing techniques, it is important to manage data to have an idea about basic information on the study. Concerning this research study, primary data were collected from 182 respondents who h used major banks in Sri Lanka with electronic banking facilities

Table 1:Descriptive Statistic

Descriptive	%
<b>Gender</b>	
Male	45.6
Female	54.4

Descriptive	%
<b>Marital Status</b>	
Single	61
Married	39

<b>Age Level</b>	
25-35	31.3
35-45	14.8
45-55	8.8
Above 55	2.7
Below 25	42.3
<b>Place</b>	
From Home	53
From work place	33.5
In the Bank	11
Other Place	2

<b>Education Level</b>	
Up to O/L	19
A/L Passed	42.9
Degree Passed	27
Above Degree	11.5

The above table shows the 54.4% of the sample consists of a female while around 45.6% of the sample consists of males. According to the result of a summary of the respondents, 31.3% of the sample are aged between 25 to 35 customers in those five banks. 14.8%, 8.8%, 2.7% and 42.3% ages are respectively between 35-45, 45-55, above 55 and below 25 respondents in those four bank sample. Further age below the 25 bank customers has represented a higher percentage of electronic banking services used. Descriptive table shows the sample of those four bank customers' marital status composition. Here around 39% of the sample consists of married customers while around 61% of the customers consist of single. According to the result of a summary of the respondent, 42.9% of the sample who are A/L passed bank customers in used electronic banking services those four banks while 27% degree holders and 19%,11.5% respectively represent O/L qualification customers and above degree customers. It means education level is directly influenced for using electronic banking services during the pandemic period. 53% shows a higher degree of used electronic banking

from home and respectively 33.5%, 11.0% shows from the work place and in the bank while 2% present lowest degree of used E-banking by the sample in other places. It means this Pandemic period more customers tend to use online banking products.

Construct reliability as known as composite reliability used to measure the internal consistency of the Likert scale items and this measures much equal to the Cronbach’s alpha test Richard *et al.*(2003). The amount of variation collected by the concept concerning the amount of variance due to measurement error is measured by AVE. Table 2 shows composite reliability and AVE in those six factors. AVE should be greater than 0.5 and CR Should be greater than 0.6 because AVE and CR cut of the value bound in 0.5 and 0.6 levels. The result shows all the six factors CR is greater than 0.6 and reliability factor AVE is less than 0.5 cutoff mark and other variables AVE is greater than 0.5 bus Reliability factor AVE is near to the 0.5 (0.471142) there for based on this evidence researcher can express questionnaire has a quite good level.

Table 2:Reliability and validity

	Composite reliability	AVE	REL	ASS	SEC_PR	EASE	EMP	CS
REL	0.727	0.471	<b>0.794</b>					
ASS	0.782	0.545	0.679	<b>0.686</b>				
SEC_PR	0.776	0.537	0.713	0.686	<b>0.739</b>			
EASE	0.837	0.632	0.683	0.678	0.701	<b>0.733</b>		
EMP	0.855	0.664	0.631	0.63	0.665	0.579	<b>0.795</b>	

CS	0.836	0.631	0.597	0.616	0.623	0.573	0,623	<b>0.815</b>
----	-------	-------	-------	-------	-------	-------	-------	--------------

Measure the discriminant validity to use Pearson's Correlation matrix and the square root of average variance extracted. This validity testing is used to measure contrast that should not be connected in practice. Above the table, bold values are shown square root of AVE and other values are correlation coefficients of variables. Cross-check with from AVE values to horizontal and vertical correlation coefficients. The square root of AVE should be more than the row and column correlation coefficient values.

The Pearson correlation value shows whether the variables under examination are connected positively or negatively. The association strength is fairly strong when the correlation coefficient equals one.

With a Pearson correlation value of +.679, there was a statistically significant association between reliability and customer satisfaction at the 0.01 level, according to table 3. It reveals a favorable association between client satisfaction and reliability.

With a Pearson correlation value of +.713, the relationship between assurance and customer satisfaction was statistically significant at the 0.01 level. It demonstrates that customer satisfaction and certainty have a beneficial relationship. With a Pearson correlation value of +.683, the association between security and privacy and customer satisfaction was statistically significant at the 0.01 level. It demonstrates that consumer satisfaction and security and privacy have a beneficial relationship. With a Pearson correlation value of +.631, the relationship between ease of use and customer satisfaction was statistically significant at the 0.01 level. It demonstrates that customer satisfaction and

simplicity of use have a favorable relationship. With a Pearson correlation value of +.597, the relationship between empathy and customer satisfaction was statistically significant at the 0.01 level. It demonstrates that customer satisfaction and empathy have a beneficial relationship.

Table 3:Correlation Analysis

		<b>Correlations</b>					
		CS	REL	ASS	SEC_PR	EASE	EMP
CS	Pearson Correlation	1	.679**	.713**	.683**	.631**	.597**
	Sig. (2-tailed)		.000	.000	.000	.000	.000
	N	182	182	182	182	182	182
REL	Pearson Correlation	.679**	1	.686**	.678**	.630**	.616**
	Sig. (2-tailed)	.000		.000	.000	.000	.000
	N	182	182	182	182	182	182
ASS	Pearson Correlation	.713**	.686**	1	.701**	.665**	.623**
	Sig. (2-tailed)	.000	.000		.000	.000	.000
	N	182	182	182	182	182	182
SEC_PR	Pearson Correlation	.683**	.678**	.701**	1	.579**	.573**
	Sig. (2-tailed)	.000	.000	.000		.000	.000
	N	182	182	182	182	182	182

EASE	Pearson Correlation	.631**	.630**	.665**	.579**	1	.623**
	Sig. (2-tailed)	.000	.000	.000	.000		.000
	N	182	182	182	182	182	182
EMP	Pearson Correlation	.597**	.616**	.623**	.573**	.623**	1
	Sig. (2-tailed)	.000	.000	.000	.000	.000	
	N	182	182	182	182	182	182

\*\* . Correlation is significant at the 0.01 level (2-tailed).

Source: SPSS output

From the above results, it was evident that E-Banking service quality dimensions were more strongly positively related to the customer satisfaction. To test this hypothesis, regression analysis was used (see table 4). From the table 4, R square also known as the coefficient of determination, it refers to determining how much variation in the dependent variable is explained by variations in the independent variables. The R-square is 0.623 in the example above. This suggests that 62.3 percent of the variation in customer satisfaction may be explained by differences in the quality of electronic banking services. The adjusted R square, which indicates the real variation in the dependent variable owing to changes in the independent variable, is 0.613, indicating that there was a 61.3 percent variance in customer satisfaction due to changes in E-banking service quality, according to this conclusion in table 4.20. The Durbin Watson statistic was 1.872 and between +1 and +3, indicating that the observation's independence had been fulfilled.

Table 4: Model Summary

Model	R	R Square	Adjusted R Square	Std. Error of the Estimate	Change Statistics					Durbin-Watson
					R Square Change	F Change	df1	df2	Sig. F Change	
1	.790 <sup>a</sup>	.623	.613	.46036	.623	58.293	5	176	.000	1.872

a. Predictors: (Constant), EMP, SEC\_PR, EASE, REL, ASS

b. Dependent Variable: CS

Source: SPSS output

The E-banking service quality dimension influences customer satisfaction, as indicated in the regression formula, which is the application of regression Table 5.

Table 5:Regression of E-banking service quality dimension towards customer satisfaction

Model		Unstandardized Coefficients		Standardized Coefficients	t	Sig.
		B	Std. Error	Beta		
1	(Constant)	.156	.235		.667	.506
	REL	.231	.086	.196	2.694	.008
	ASS	.285	.081	.270	3.530	.001
	SEC_PR	.254	.079	.228	3.222	.002

EASE	.128	.063	.140	2.051	.042
EMP	.082	.060	.090	1.366	.174

a. Dependent Variable: CS

Source: SPSS output

Customer satisfaction is affected by Reliability by 23.1 percent. Furthermore, the significance level is 0.008, which is less than the alpha level ( $P = 0.05$ ). Referring this result enough to accept  $H_1$  and reject  $H_0$ . Customer satisfaction is affected by the assurance by 28.5%. The level of significance is 0.001, which is lower than the 0.005 value of significance and t-value is more than 2.0 therefore this evidence enough to accept  $H_2$  and reject  $H_0$ . Security and privacy had an impact of 25.4 percent on customer satisfactions and this P-value is lower than the 0.05. In addition, this t-value is above 2.0 therefore this result can provide evidence to Accept  $H_3$  and reject  $H_0$ . Furthermore, Ease of use is affected 12.8% on customer satisfaction. The significance level is 0.002. It is lower than the 0.05 significant level and its t-value is above the 2.0 therefore this evidence enough to accept  $H_4$  and reject  $H_0$ .

According to above four variables result the study have been achieved research objectives. In other hand Empathy variable indicated 8.2% impact on customer satisfaction during the Covid-19 pandemic period in Sri Lanka. And its t-value is less than 2.0 and P-value is more than 0.05. Based on this result evidence enough to accept  $H_0$  and reject  $H_5$ . It means empathy variable provided new perspective to Sri Lanka banking industry during the pandemic period.

## 5. Conclusion

Throughout the study, the researchers attempted to fill a knowledge gap by determining the impact of electronic



banking service quality (Reliability, Assurance, Security & Privacy, Ease of Use, and Empathy service quality dimensions) on customer satisfaction in Sri Lanka during the COVID-19 pandemic period. During the COVID -19 pandemic period in Sri Lanka, the researcher identified that there are many types of research relating to electronic banking and customer satisfaction, but there is no research that directly addresses the determination of electronic banking service quality dimensions on bank customer satisfaction involve with Pandemic outbreak. Furthermore, there is no study available, especially for the Sri Lankan context, that combines all of the aspects that influence e-banking service quality and the impact on bank customer satisfaction throughout the pandemic era. The study objective is to determine the influence of E-banking service quality on customer satisfaction in Sri Lanka during the Covid-19 pandemic period.

This study confirms that electronic banking service quality dimensions such as Reliability, Assurance, Security & Privacy, Ease of Use have a significant positive impact and empathy has a negative impact on customer satisfaction during the Covid-19 pandemic period in banking service industries. According to this study the researchers have derived a positive impact of the electronic banking service quality dimensions such as reliability, assurance, security & privacy, ease of use on customer satisfaction during the COVID 19 pandemic period in Sri Lanka. Empathy has a negative impact on customer satisfaction during the pandemic period in Sri Lanka. To the strategic movement of commercial bank sector and create COVID 19 Crisis advantages in this industry Sri Lanka commercial bank sector has the highest impact for the electronic banking service quality on bank customer satisfaction. If a banking sector invests more in improving E-banking service quality dimensions it will help to increase their customer base and market volume. Then after the electronic banking service reliability has a high impact on the bank customer satisfaction during the pandemic

period commercial banking sector in Sri Lanka.

This study suggests improve customer satisfactions bankers should equal focus on all the variables in positive manner because throughout this pandemic period customer's general life styles changed rapidly and they live with under pressure therefore empathy should be developing and maintain customer friendly electronic banking services. These five factors have a significant positive impact on bank customer satisfaction during the COVID-19 pandemic period in Sri Lanka. This study is used by commercial banks in Sri Lanka when they make new strategic plans for their electronic banking activities and take a correct direction for their service quality improvements during the COVID 19 pandemic period and it will help them to achieve their targets.

## References

- Ahamed, A. M. (2020). The influence of electronic banking service quality on customer satisfaction of banks in tripoli city, Libya. *International journal of innovation and creativity*, 13.
- Cabanillas, F. L., Leiva, F. M., & Guardia, F. R. (2013). The determinants of satisfaction with e-banking. *Industrial management & data systems*, 113.
- Davis, F. (1989). Perceived usefulness, perceived ease of use, and user acceptance of information technology. *MIS quality*, 319-339.
- Hammoud, J., Bizri, R. M., & Baba, I. E. (2018). The impact of E-banking service quality on customer satisfaction: Evidence from the Lebanese banking sector. *SAGE open-Research paper*, 1.

- Haq, I. U., & Awan, T. M. (2020). Impact of E-banking service quality on e-loyalty in pandemic times through interplay of e-satisfaction. *XIMB Journal of Management*, 17.
- Hussaien, A. S., Sivathmajasarma, J., Abeysekara, A. K., Hansani, H., Thelijjagoda, S., & Madhavika, W. (2020). Service quality and customer satisfaction in the banking sector during COVID-19 - An Empirical analysis of Sri Lanka. *Global Journal of management and business research*, 20.
- Jindal, M., & Sharma, V. L. (2020). Usability of online banking in India during COVID-19 pandemic. *International Journal of Engineering and management research*, 10.
- Kawimbe, S. (2020). Digital disruption and the impact on service delivery by banks in Zambia: customer perspective. *International journal of information research and review*, 07.
- Ketema, E., & Selassie, Y. W. (2020). The impact of M-banking quality service on customers satisfaction during Covid-19 lockdown: The case of Bank of Abyssinia. *African Journal of marketing management*, 12.
- KPMG. (2020, November). Retrieved from KPMG Corporation web site: <https://assets.kpmg.lk>
- Pakurar, M., Haddad, H., Nagy, J., Popp, J., & Olah, J. (2019). The service quality dimensions that affect customer satisfaction in the Jordanian banking sector. *Journal of sustainability*. doi:10.3390/su11041113
- Parasuraman, A; Zeithmal, V A; Berry, L L;. (1994). Reassessment of expectations as a comparison standard on measuring service quality Implication for further research. *Journal of Marketing*, 58, 111-124.

- Parasuraman, A; Zeithmal, V A; Malhotra, A. (2005). Electronic service quality A multiple scales for assessing electronic service quality. *Journal of service research*, 7, 213-233.
- Richard, G; Netemeyer; William, O; Subhash, S;. (2003). *Scaling procedure: Issues and applications*. SAGE.
- Shabbir, M. S., Rehma, A. K., & Shabbier, T. (2016). Combine effect of automated services and traditional services quality on customer satisfaction: evidence from banking sector of Pakistan. *International journal of economics & Management Sciences*, 5.
- Tetteh, T. E. (2021). Electronic banking service quality: perception of customers in the Greater Accra region of Ghana. *Journal of internet commerce*. doi:10.1080/15332861.2020.1870340
- Warren, S., & Brandeis, L. (1890). *The right to privacy, Harvard law review* (Vol. 4).
- Westin, F. (1987). *Privacy and freedom*. Athenaeum, New York.
- WHO. (2020). *WHO.int*. Retrieved from world health organization web site: <https://www.who.int>
- Zeithmal, V A; Parasuraman , A; Malhotra, A. (2000). A conceptual framework for understanding E-service quality Implication for future research and management practice. *Journals of marketing*, 49, 41-50.
- Zeithmal, V A; Parasuraman, A; Malhotra, A. (2002). Service quality delivery through websites: A critical review of extant knowledge. *Journal of the Academy of Marketing Science*, 30, 362-375.



**Tel: +94 011 2903 554**

**Web: <http://fcms.kln.ac.lk/dep/dfin/index.php>**

**Email: [dfin@kln.ac.lk](mailto:dfin@kln.ac.lk)**



ISSN 2827-7236



9 772827 723004